



FINISH: P/C MATTE BLACK

AP ASSOCIATED PROJECTS COMMERCIAL BUILDERS,
PROJECT MANAGERS,
PLANNERS & DESIGNERS

T 03 8787 3000 F 03 8787 3025
48-58 Cyber Loop, Dandenong South VIC 3175

Rev	Date	Description

ALL DIMENSIONS IN (mm)
UNLESS OTHERWISE SPECIFIED
BREAK ALL SHARP EDGES

TOLERANCES
(BEFORE PAINTING
& AFTER PLATING)
X ± 1.00
X.X ± 0.50
X.XX ± 0.10
ANGLES ± 0.5°

A01- RENDER

CLIENT: RFA

PROJ. NO.: TBA

PART NO.: --

Revision --

Page 1

SIGNAGE CLIPPER
W900 LOW HEIGHT HEAVY DUTY GONDOLA

PRODUCT CODE: RFA6137

Date: 11/10/2023

Drawn by PS

Checked by --

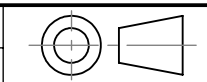

DO NOT SCALE

Scale@A3 1:5

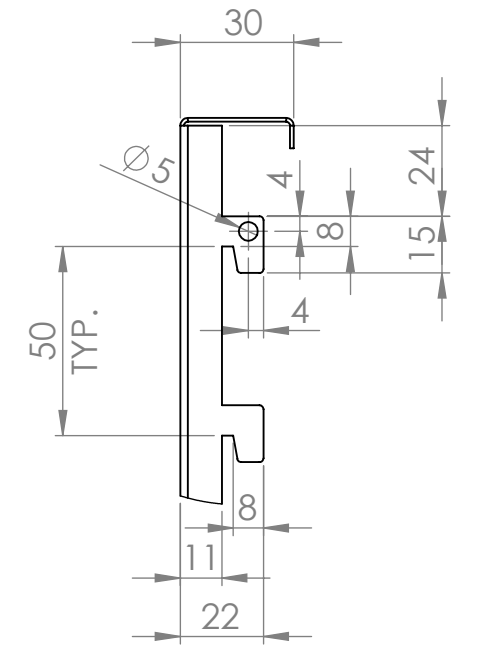
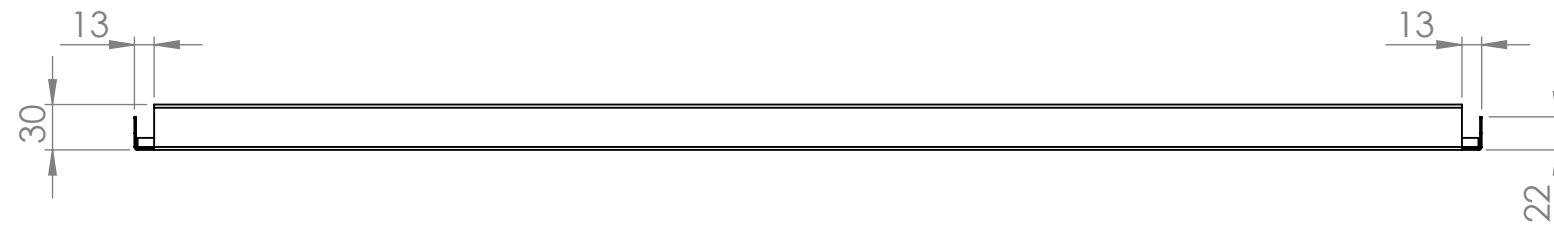
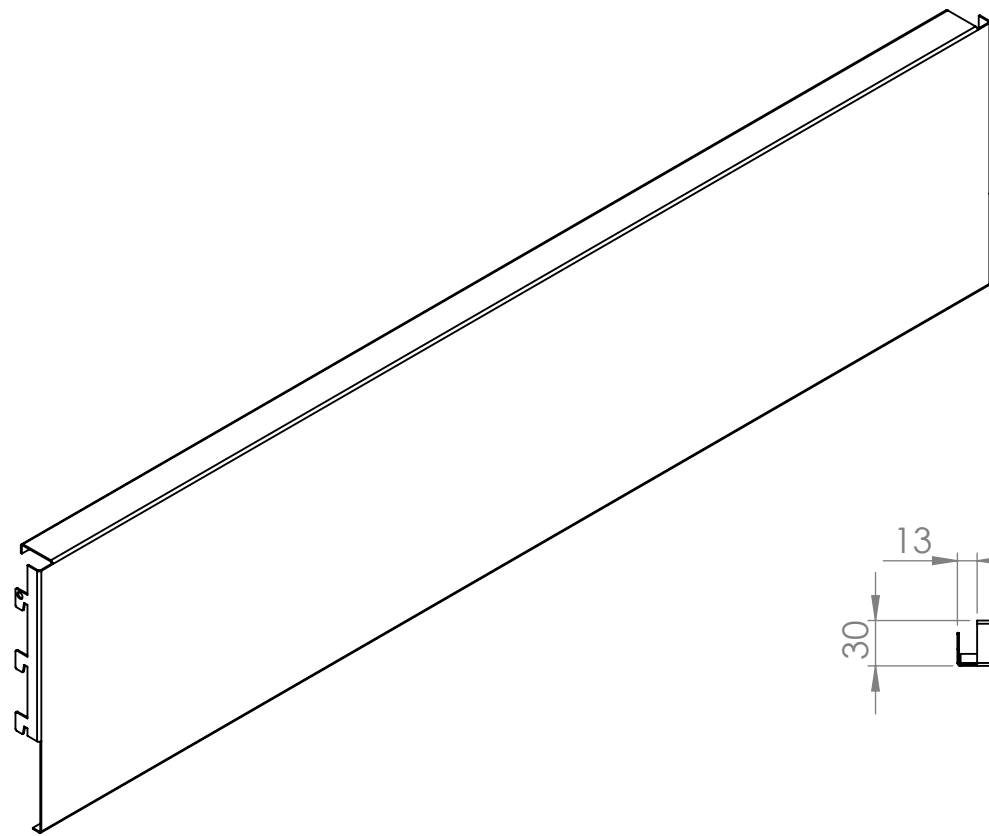

DETAIL A
SCALE 1 : 2

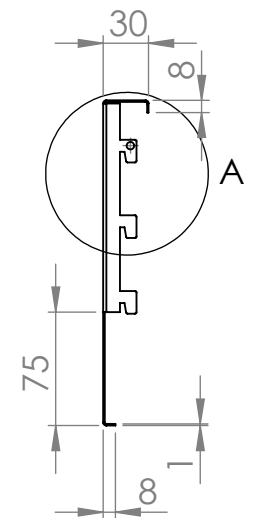
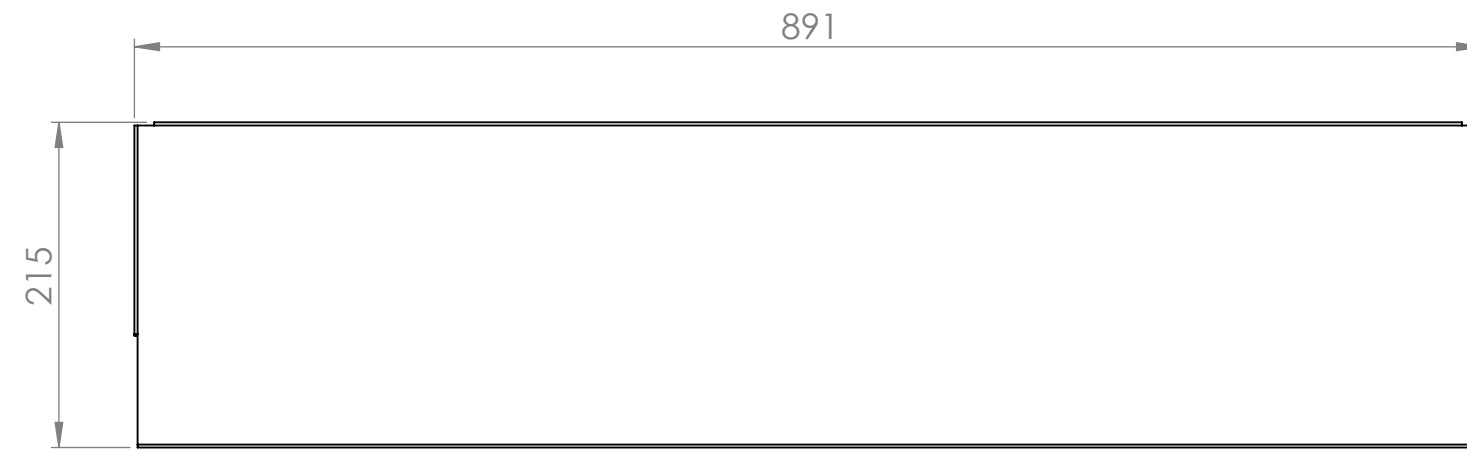

Rev	Date	Description

ALL DIMENSIONS IN (mm)
UNLESS OTHERWISE SPECIFIED
BREAK ALL SHARP EDGES

TOLERANCES
(BEFORE PAINTING
& AFTER PLATING)
X ± 1.00
X.X ± 0.50
X.XX ± 0.10
ANGLES ± 0.5°

A02- DIMENSIONS

CLIENT: RFA
PROJ. NO.: TBA
PART NO.: --
Revision --
Page 2

SIGNAGE CLIPPER
W900 LOW HEIGHT HEAVY DUTY GONDOLA

PRODUCT CODE: **RFA6137**

Date: 11/10/2023

Drawn by PS

Checked by --

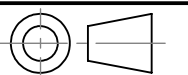

DO NOT SCALE

Scale@A3 1:5