



FINISH: P/C MATTE BLACK

Rev	Date	Description

ALL DIMENSIONS IN (mm)
UNLESS OTHERWISE SPECIFIED
BREAK ALL SHARP EDGES

TOLERANCES
(BEFORE PAINTING
& AFTER PLATING)
X ± 1.00
X.X ± 0.50
X.XX ± 0.10
ANGLES ± 0.5°

A01- RENDER

CLIENT: RFA

PROJ. NO.: TBA

PART NO.: --

Revision --

Page 1

6000mm(H) x 1067mm(D)
FRAME

PRODUCT CODE: RFA6027

Date: 24/07/2023

Drawn by PS

Checked by --



DO NOT SCALE

Scale@A3 1:20

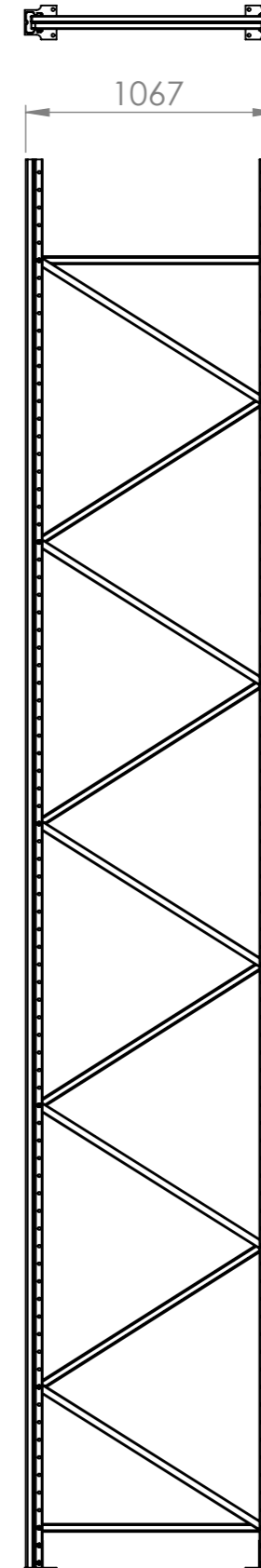
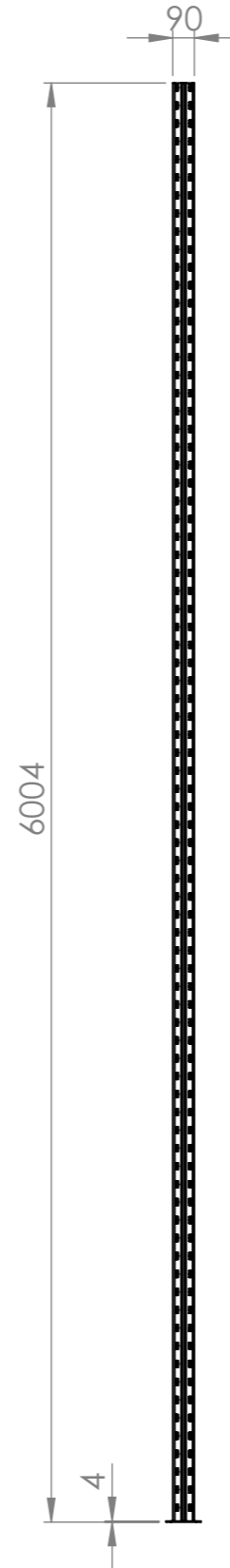
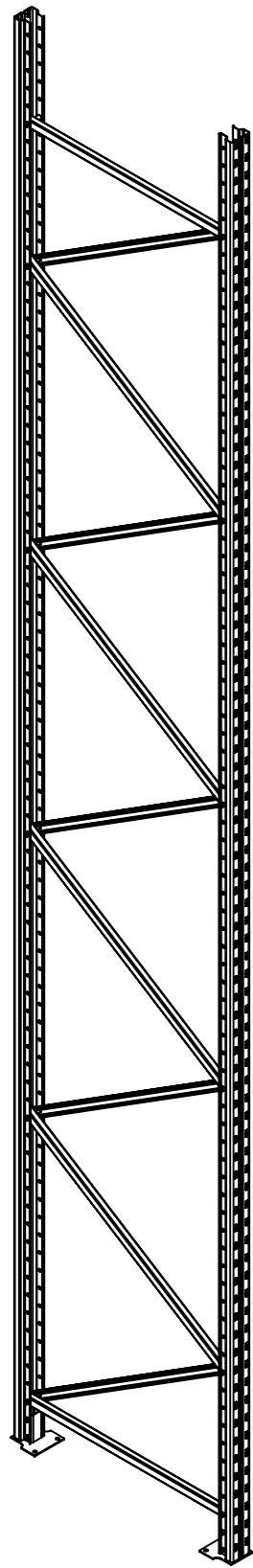

Rev	Date	Description

ALL DIMENSIONS IN (mm)
UNLESS OTHERWISE SPECIFIED
BREAK ALL SHARP EDGES

TOLERANCES
(BEFORE PAINTING
& AFTER PLATING)
X ± 1.00
X.X ± 0.50
X.XX ± 0.10
ANGLES ± 0.5°

A02- DIMENSIONS

CLIENT: RFA
PROJ. NO.: TBA
PART NO.: --
Revision --
Page 2

6000mm(H) x 1067mm(D)
FRAME

PRODUCT CODE: **RFA6027**

Date: 24/07/2023

Drawn by PS

Checked by --

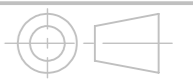

DO NOT SCALE

Scale@A3 1:30

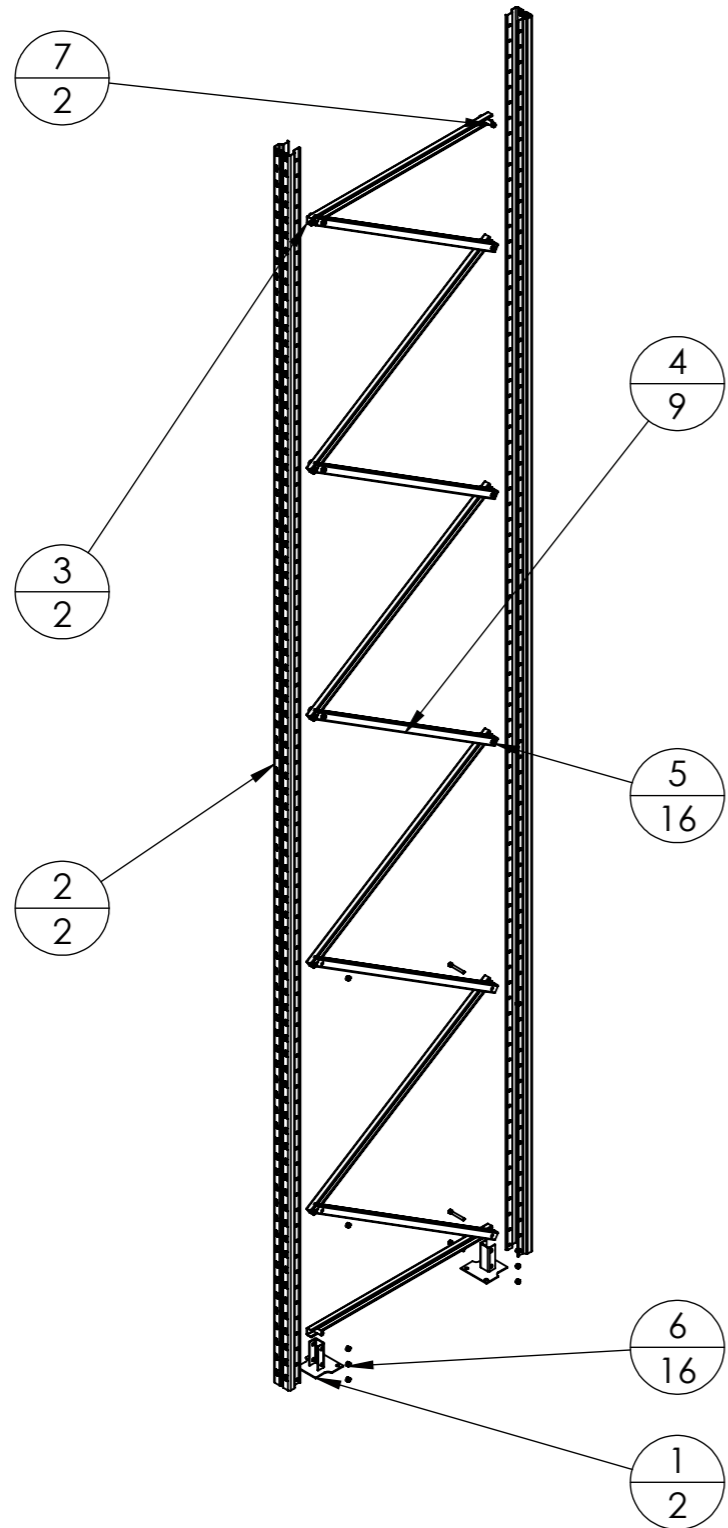

ITEM NO.	PartNo	DESCRIPTION	QTY.
1	RFA6105	FOOT FOR PALLET RACK UPRIGHT	2
2	RFA6104	6000mm(H) PALLET RACK UPRIGHT-POST	2
3	RFA6108	1067mm(D) RACK - HORIZONTAL BRACE	2
4	RFA6109	1067mm(D) RACK - DIAGONAL BRACE	9
5	RFA6114	M10x65mm BOLT - FOR BRACING	16
6	RFA6114	M10 NUT	16
7	RFA6115	M10 SPACER FOR BOLT	2

Rev	Date	Description

ALL DIMENSIONS IN (mm)
UNLESS OTHERWISE SPECIFIED
BREAK ALL SHARP EDGES

TOLERANCES
(BEFORE PAINTING
& AFTER PLATING)
X ± 1.00
X.X ± 0.50
X.XX ± 0.10
ANGLES ± 0.5°

A03- EXPLODED

CLIENT: RFA
PROJ. NO.: TBA
PART NO.: --
Revision --
Page 3

6000mm(H) x 1067mm(D)
FRAME

PRODUCT CODE: **RFA6027**

Date: 24/07/2023

Drawn by PS

Checked by --

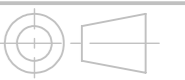

DO NOT SCALE

Scale@A3 1:30