

**FINISH: P/C MATTE BLACK**

Rev	Date	Description

ALL DIMENSIONS IN (mm)  
UNLESS OTHERWISE SPECIFIED  
BREAK ALL SHARP EDGES

TOLERANCES  
(BEFORE PAINTING  
& AFTER PLATING)  
X ± 1.00  
X.X ± 0.50  
X.XX ± 0.10  
ANGLES ± 0.5°

**A01- RENDER**

**CLIENT: RFA**

**PROJ. NO.: TBA**

**PART NO.: --**

**Revision --**

**Page 1**

**2400mm(H) x 1220mm(D)**  
**FRAME**

**PRODUCT CODE: RFA6011**

Date: 19/06/2023

Drawn by PS

Checked by --

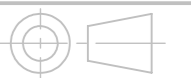

DO NOT SCALE

Scale@A3 1:10

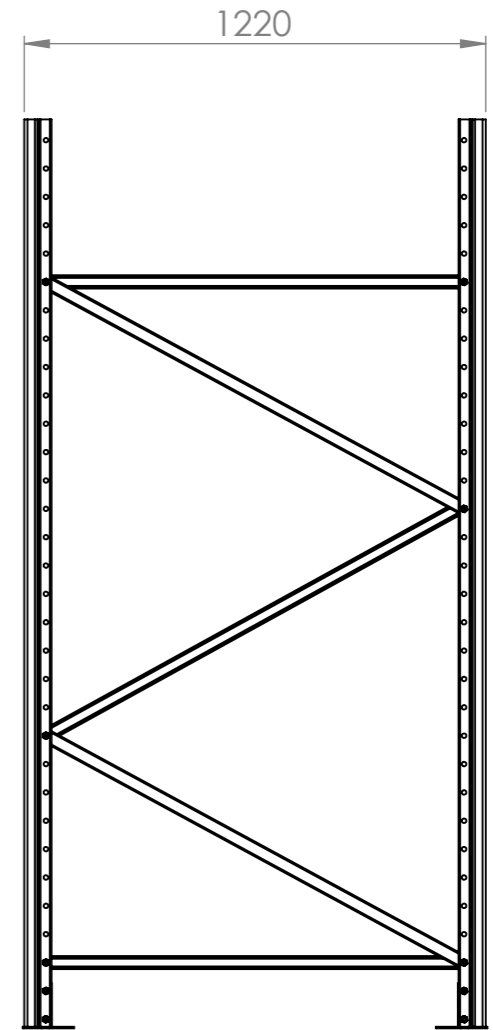
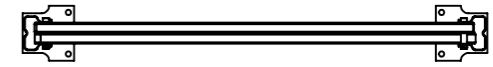
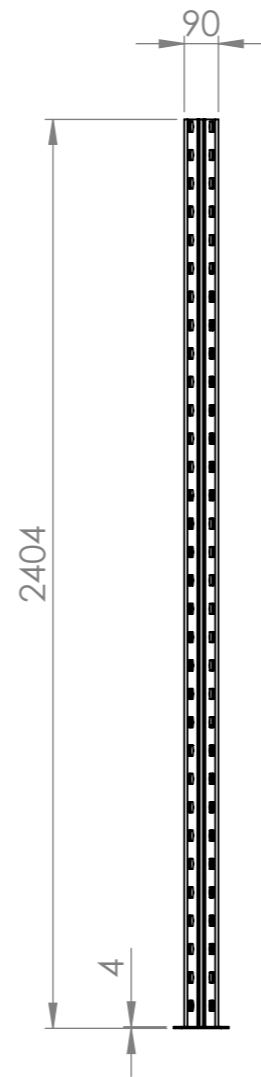
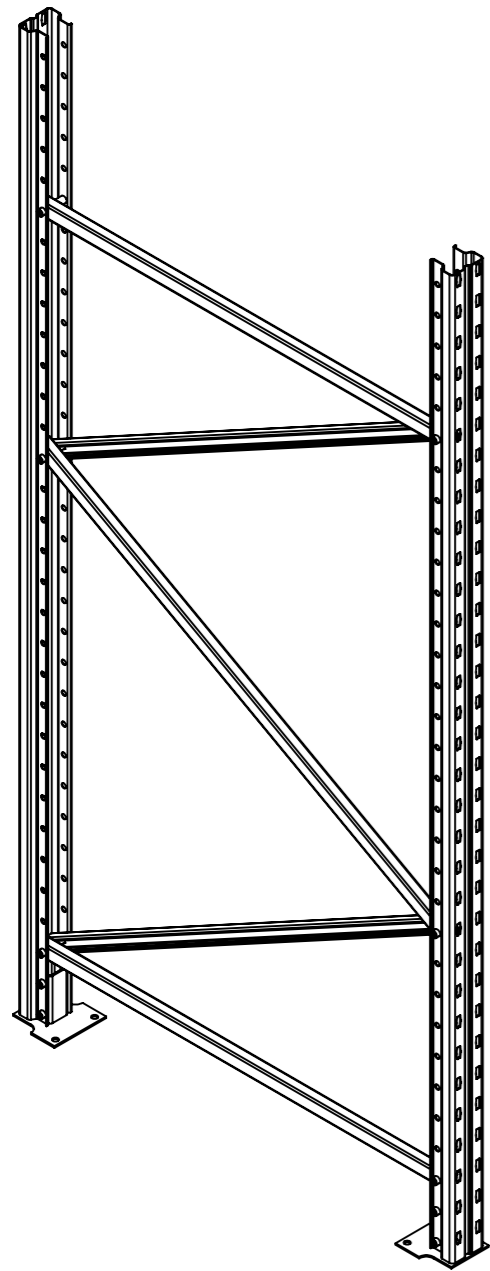

Rev	Date	Description

ALL DIMENSIONS IN (mm)  
UNLESS OTHERWISE SPECIFIED  
BREAK ALL SHARP EDGES

TOLERANCES  
(BEFORE PAINTING  
& AFTER PLATING)  
X ± 1.00  
X.X ± 0.50  
X.XX ± 0.10  
ANGLES ± 0.5°

**A02- DIMENSIONS**

CLIENT: RFA  
PROJ. NO.: TBA  
PART NO.: --  
Revision --  
Page 2

2400mm(H) x 1220mm(D)  
FRAME

PRODUCT CODE: **RFA6011**

Date: 19/06/2023

Drawn by PS

Checked by --

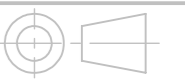

DO NOT SCALE

Scale@A3 1:20

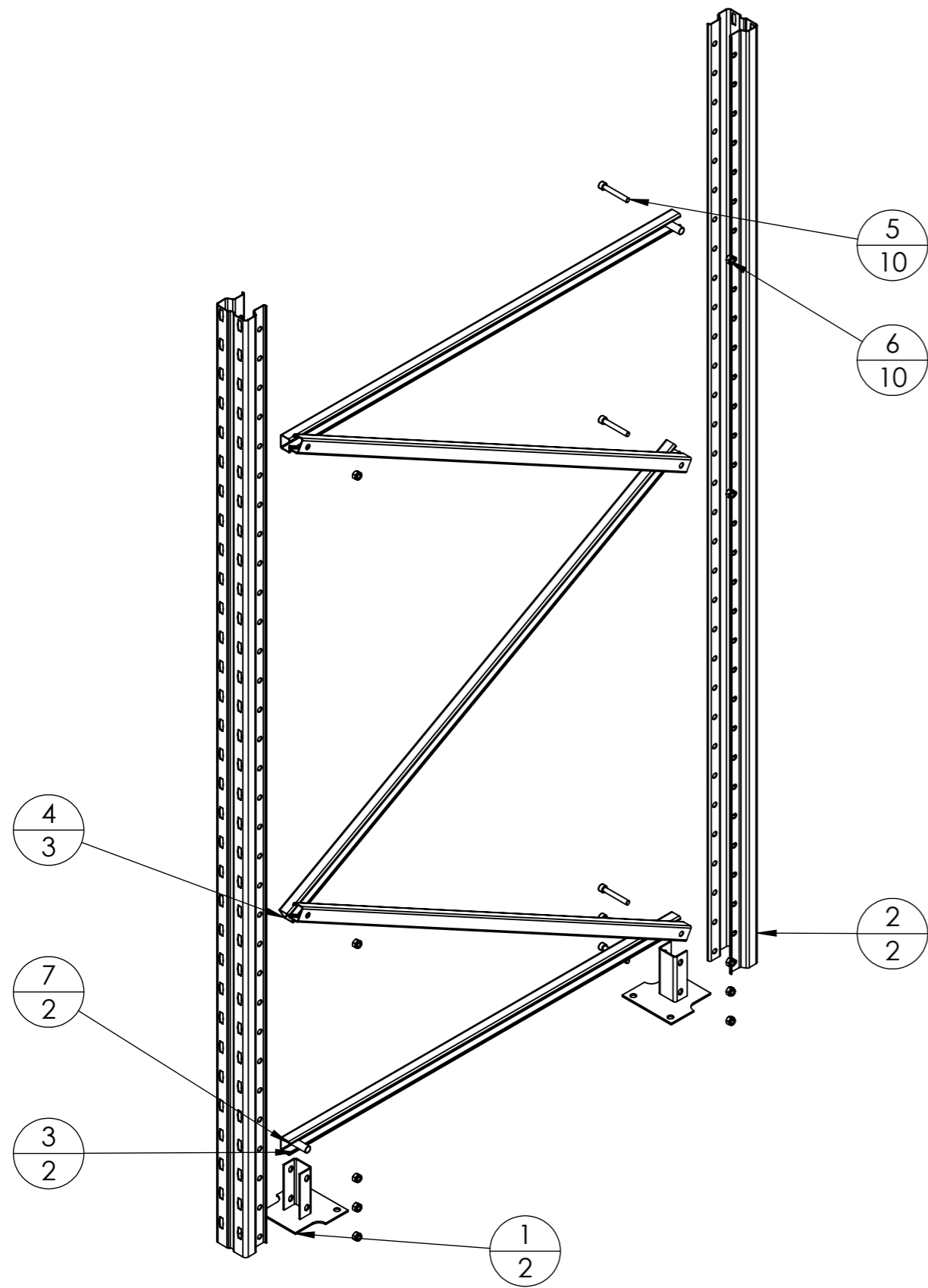

ITEM NO.	PartNo	DESCRIPTION	QTY.
1	RFA6105	FOOT FOR PALLET RACK UPRIGHT	2
2	RFA6101	2400mm(H) PALLET RACK UPRIGHT-POST	2
3	RFA6110	1220mm(D) RACK - HORIZONTAL BRACE	2
4	RFA6111	1220mm(D) RACK - DIAGONAL BRACE	3
5	RFA6114	M10x65mm BOLT - FOR BRACING	10
6	RFA6114	M10 NUT	10
7	RFA6115	M10 SPACER FOR BOLT	2

Rev	Date	Description

ALL DIMENSIONS IN (mm)  
UNLESS OTHERWISE SPECIFIED  
BREAK ALL SHARP EDGES

TOLERANCES  
(BEFORE PAINTING  
& AFTER PLATING)  
X ± 1.00  
X.X ± 0.50  
X.XX ± 0.10  
ANGLES ± 0.5°

**A03- EXPLODED**

CLIENT: RFA  
PROJ. NO.: TBA  
PART NO.: --  
Revision --  
Page 3

2400mm(H) x 1220mm(D)  
FRAME

PRODUCT CODE: **RFA6011**

Date: 19/06/2023

Drawn by PS

Checked by --



DO NOT SCALE

Scale@A3 1:20