

FINISH: P/C MATTE BLACK

Rev	Date	Description

ALL DIMENSIONS IN (mm)
UNLESS OTHERWISE SPECIFIED
BREAK ALL SHARP EDGES

TOLERANCES
(BEFORE PAINTING
& AFTER PLATING)
X ± 1.00
X.X ± 0.50
X.XX ± 0.10
ANGLES ± 0.5°

A01- RENDER

CLIENT: RFA

PROJ. NO.: TBA

PART NO.: --

Revision --

Page 1

2400mm(H) x 838mm(D)
FRAME

PRODUCT CODE: RFA6007

Date: 16/06/2023

Drawn by PS

Checked by --

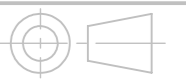

DO NOT SCALE

Scale@A3 1:20

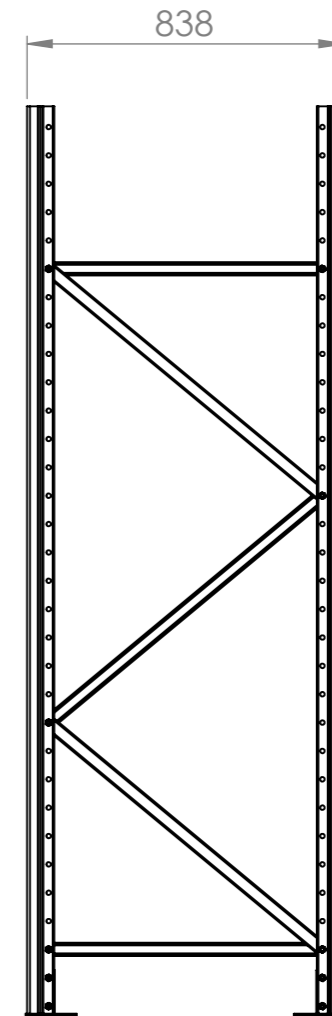
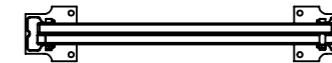
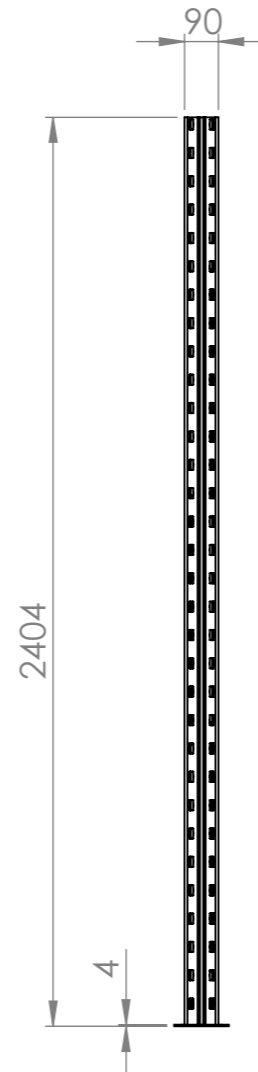
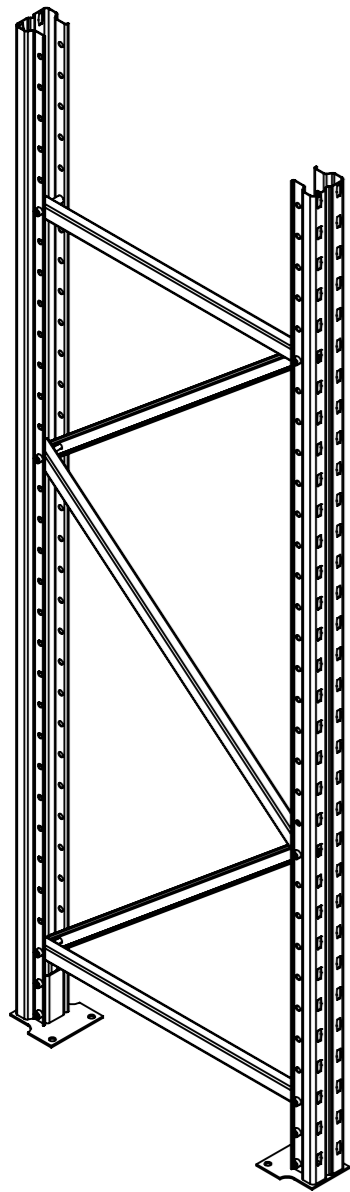

Rev	Date	Description

ALL DIMENSIONS IN (mm)
UNLESS OTHERWISE SPECIFIED
BREAK ALL SHARP EDGES

TOLERANCES
(BEFORE PAINTING
& AFTER PLATING)
X ± 1.00
X.X ± 0.50
X.XX ± 0.10
ANGLES ± 0.5°

A02- DIMENSIONS

CLIENT: RFA
PROJ. NO.: TBA
PART NO.: --
Revision --
Page 2

2400mm(H) x 838mm(D)
FRAME

PRODUCT CODE: **RFA6007**

Date: 16/06/2023

Drawn by PS

Checked by --

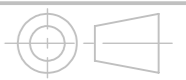

DO NOT SCALE

Scale@A3 1:20

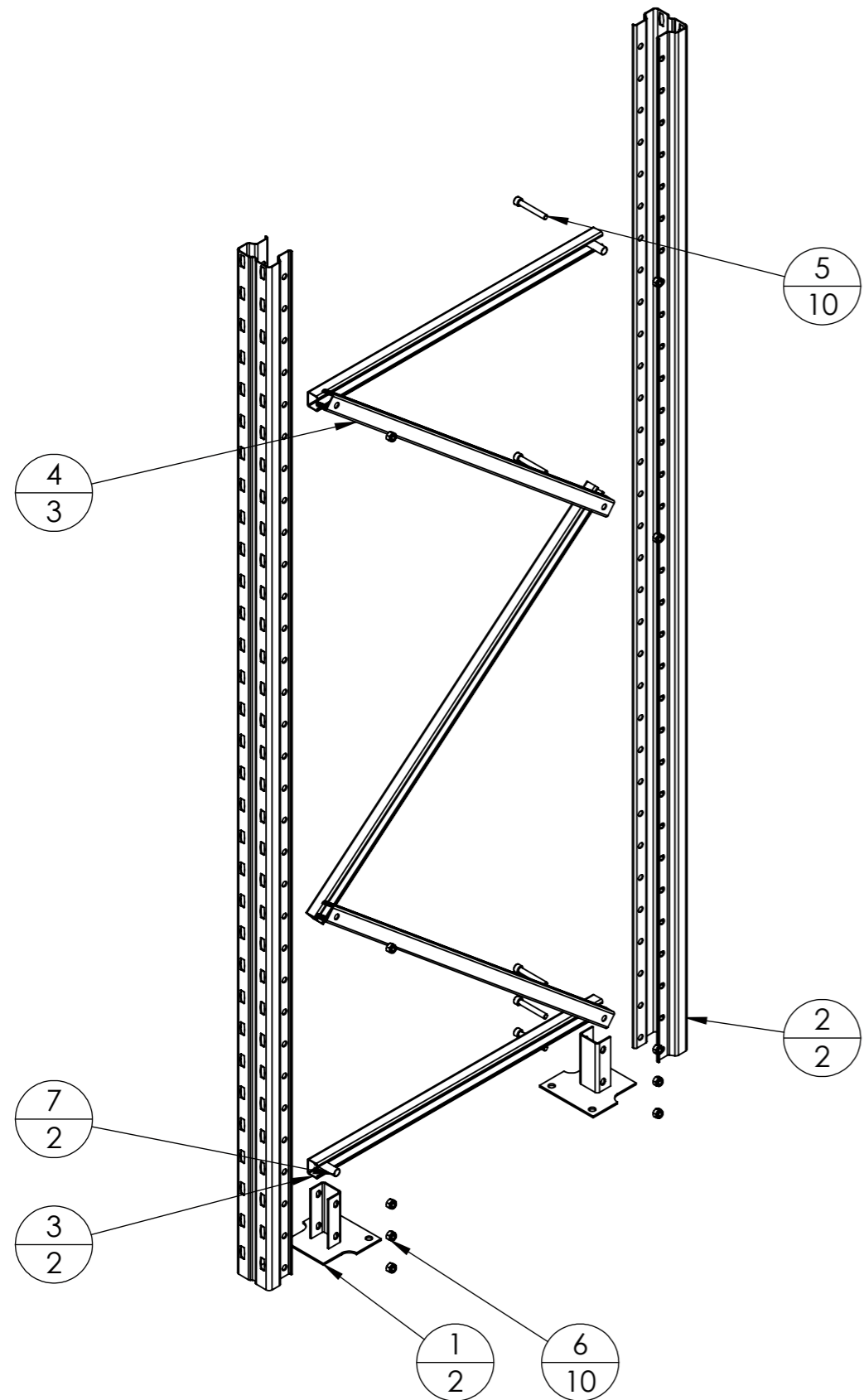

ITEM NO.	PartNo	DESCRIPTION	QTY.
1	RFA6105	FOOT FOR PALLET RACK UPRIGHT	2
2	RFA6101	2400mm(H) PALLET RACK UPRIGHT-POST	2
3	RFA6106	838mm(D) RACK - HORIZONTAL BRACE	2
4	RFA6107	838mm(D) RACK - DIAGONAL BRACE	3
5	RFA6114	M10x65mm BOLT - FOR BRACING	10
6	RFA6114	M10 NUT	10
7	RFA6115	M10 SPACER FOR BOLT	2

Rev	Date	Description

ALL DIMENSIONS IN (mm)
UNLESS OTHERWISE SPECIFIED
BREAK ALL SHARP EDGES

TOLERANCES
(BEFORE PAINTING
& AFTER PLATING)
X ± 1.00
X.X ± 0.50
X.XX ± 0.10
ANGLES ± 0.5°

A03- EXPLODED

CLIENT: RFA
PROJ. NO.: TBA
PART NO.: --
Revision --
Page 3

2400mm(H) x 838mm(D)
FRAME

PRODUCT CODE: **RFA6007**

Date: 16/06/2023

Drawn by PS

Checked by --



DO NOT SCALE

Scale@A3 1:20