

FINISH: P/C MATTE BLACK

Rev	Date	Description

ALL DIMENSIONS IN (mm)
UNLESS OTHERWISE SPECIFIED
BREAK ALL SHARP EDGES

TOLERANCES
(BEFORE PAINTING
& AFTER PLATING)
X ± 1.00
X.X ± 0.50
X.XX ± 0.10
ANGLES ± 0.5°

A01- RENDER
CLIENT: RFA
PROJ. NO.: TBA
PART NO.: --
Revision --
Page 1

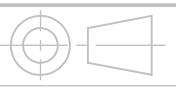
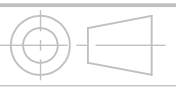
2100mm(H) x 1067mm(D) FRAME		
-		
PRODUCT CODE: RFA6003		
Date:	15/06/2023	
Drawn by	PS	
Checked by	--	
		DO NOT SCALE
		Scale@A3 1:20

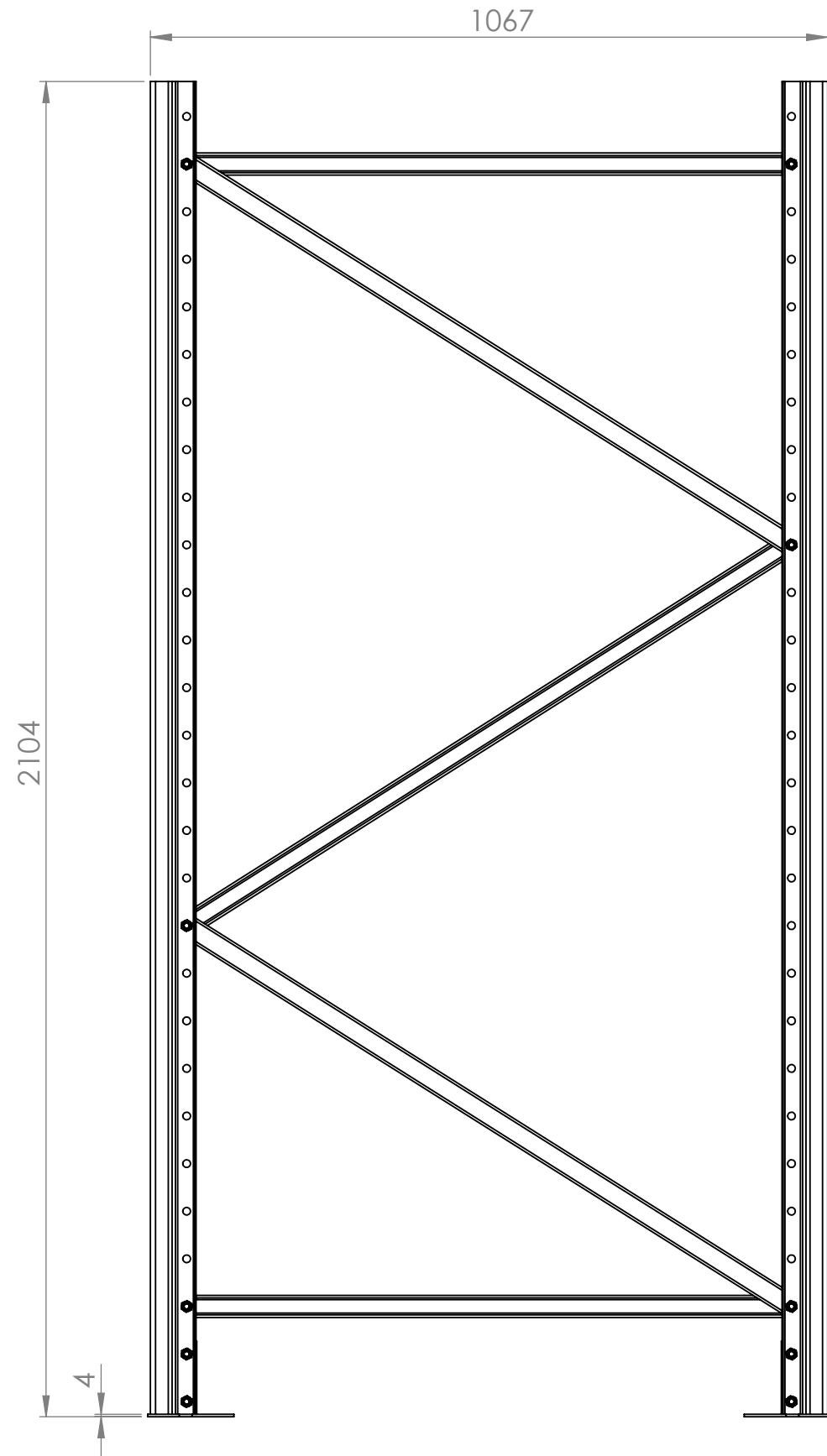
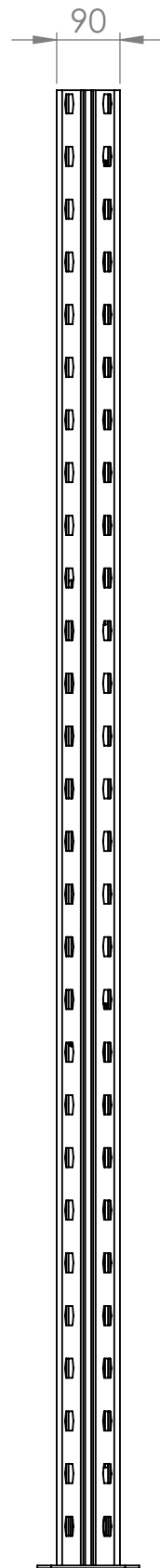
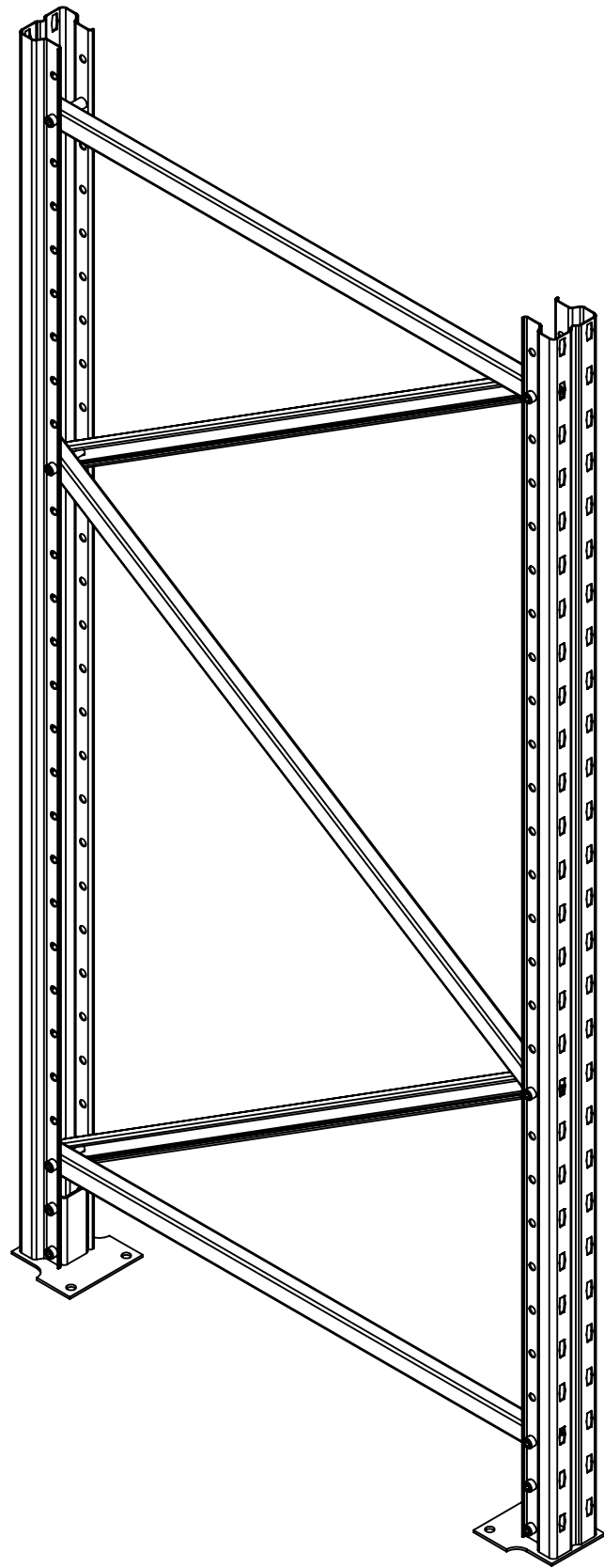

Rev	Date	Description

ALL DIMENSIONS IN (mm)
UNLESS OTHERWISE SPECIFIED
BREAK ALL SHARP EDGES

TOLERANCES
(BEFORE PAINTING
& AFTER PLATING)
X ± 1.00
X.X ± 0.50
X.XX ± 0.10
ANGLES ± 0.5°

A02- DIMENSIONS

CLIENT: RFA
PROJ. NO.: TBA
PART NO.: --
Revision --
Page 2

2100mm(H) x 1067mm(D)
FRAME

PRODUCT CODE: RFA6003

Date: 15/06/2023

Drawn by PS

Checked by --

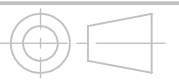

DO NOT SCALE

Scale@A3 1:10

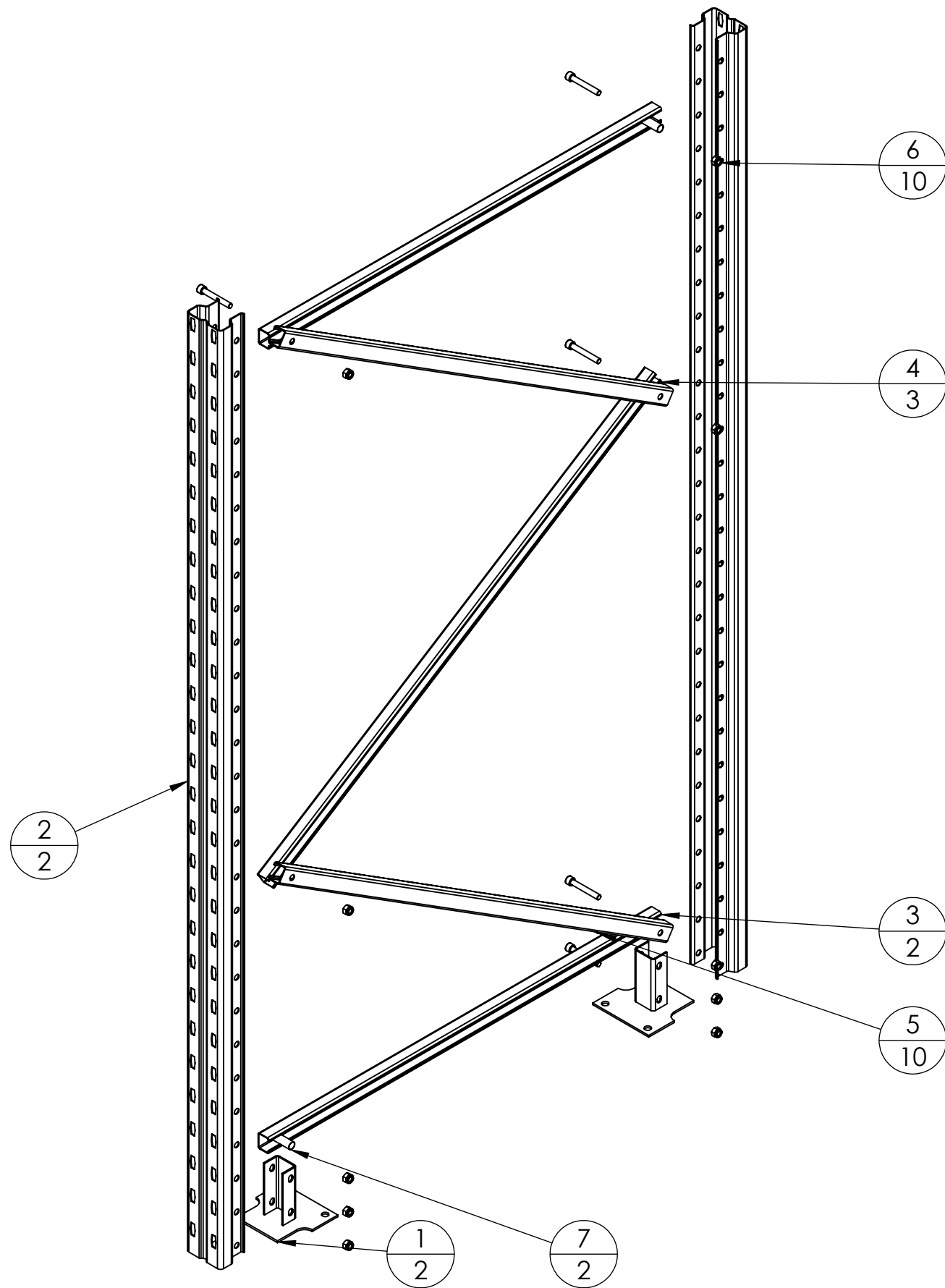

ITEM NO.	PartNo	DESCRIPTION	QTY.
1	RFA6105	FOOT FOR PALLET RACK UPRIGHT	2
2	RFA6100	2100mm(H) PALLET RACK UPRIGHT-POST	2
3	RFA6108	1067mm(D) RACK - HORIZONTAL BRACE	2
4	RFA6109	1067mm(D) RACK - DIAGONAL BRACE	3
5	RFA6114	M10x65mm BOLT - FOR BRACING	10
6	RFA6114	M10 NUT	10
7	RFA6115	M10 SPACER FOR BOLT	2

Rev	Date	Description

ALL DIMENSIONS IN (mm)
UNLESS OTHERWISE SPECIFIED
BREAK ALL SHARP EDGES

TOLERANCES
(BEFORE PAINTING
& AFTER PLATING)
X ± 1.00
X.X ± 0.50
X.XX ± 0.10
ANGLES ± 0.5°

A03- EXPLODED

CLIENT: RFA
PROJ. NO.: TBA
PART NO.: --
Revision --
Page 3

2100mm(H) x 1067mm(D)
FRAME

PRODUCT CODE: **RFA6003**

Date: 15/06/2023

Drawn by PS

Checked by --

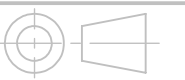

DO NOT SCALE

Scale@A3 1:10