



T 03 8787 3000 F 03 8787 3025  
 48-58 Cyber Loop, Dandenong South  
 VIC 3175 (AUSTRALIA)

© COPYRIGHT. This drawing is the exclusive property of Associated Projects Pty Ltd. It is subject to protection and is strictly confidential. Reproduction in whole or in part is prohibited without obtaining prior permission in writing from the proprietor.

Rev	Date	Description

ALL DIMENSIONS IN (mm)  
 UNLESS OTHERWISE SPECIFIED  
 BREAK ALL SHARP EDGES

TOLERANCES  
 (BEFORE PAINTING  
 & AFTER PLATING)  
 X ± 1.00  
 X.X ± 0.50  
 X.XX ± 0.10  
 ANGLES ± 0.5°

A01- -  
 CLIENT: -  
 PROJ. NO.: TBA  
 FINISH: P/C MATTE BLACK  
 MAT'L: MILD STEEL  
 Page 1

CLIP IN GRAPHIC FRAME - W900XH1380 - FOR CLIP IN GRAPHIC PANEL

PRODUCT CODE: **RFA2362**

Date: 30/10/2023

Drawn by DH

Checked by NP

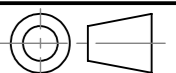

DO NOT SCALE

Scale@A3 1:1



RENDER WITH INSERTED ARTWORK



T 03 8787 3000 F 03 8787 3025  
48-58 Cyber Loop, Dandenong South  
VIC 3175 (AUSTRALIA)

© COPYRIGHT. This drawing is the exclusive property of Associated Projects Pty Ltd. It is subject to protection and is strictly confidential. Reproduction in whole or in part is prohibited without obtaining prior permission in writing from the proprietor.

Rev	Date	Description

ALL DIMENSIONS IN (mm)  
UNLESS OTHERWISE SPECIFIED  
BREAK ALL SHARP EDGES

TOLERANCES  
(BEFORE PAINTING  
& AFTER PLATING)  
X ± 1.00  
X.X ± 0.50  
X.XX ± 0.10  
ANGLES ± 0.5°

**A02- RENDER**  
**CLIENT:** -  
**PROJ. NO.:** TBA  
**FINISH:** P/C MATTE BLACK  
**MAT'L:** MILD STEEL  
**Page** 2

CLIP IN GRAPHIC FRAME - W900XH1380 - FOR CLIP  
IN GRAPHIC PANEL

**PRODUCT CODE:** RFA2362

**Date:** 30/10/2023

**Drawn by** DH

**Checked by** NP

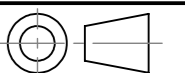

DO NOT SCALE

Scale@A3 1:1

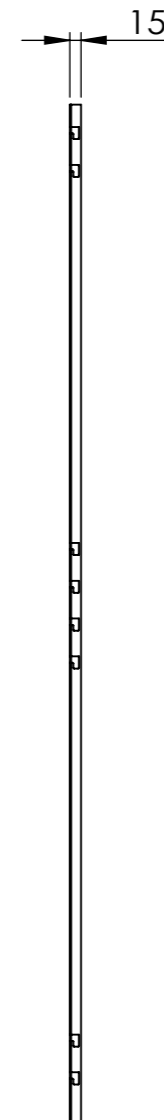
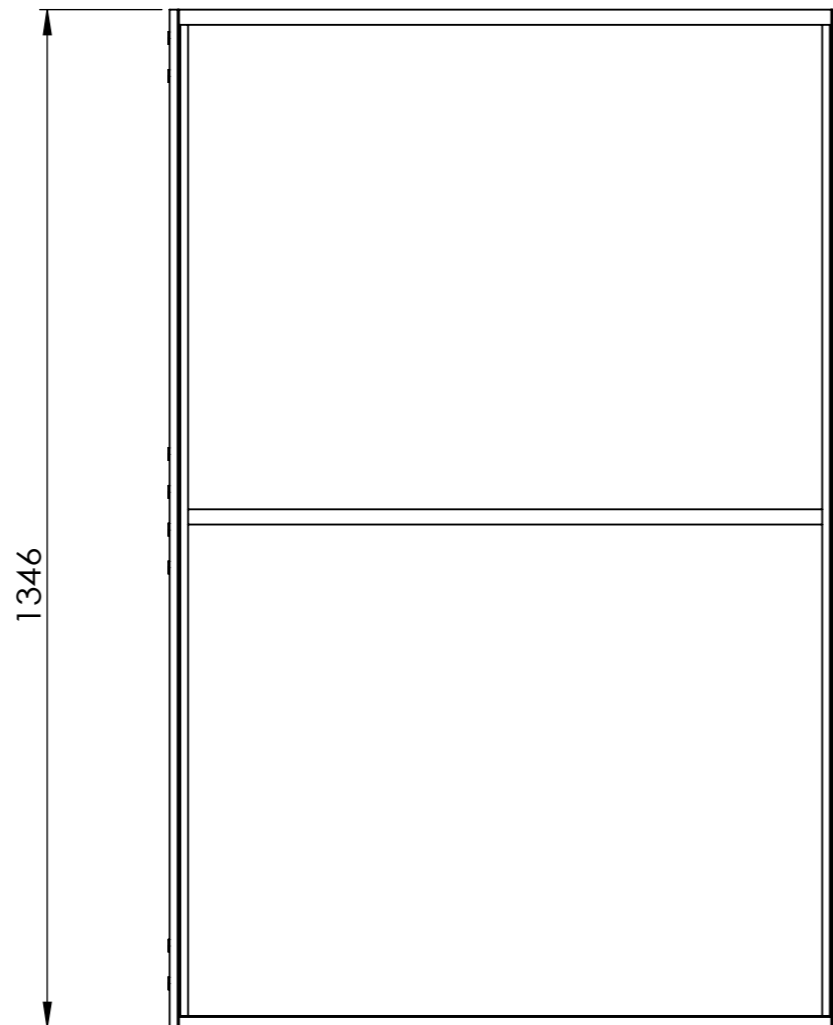
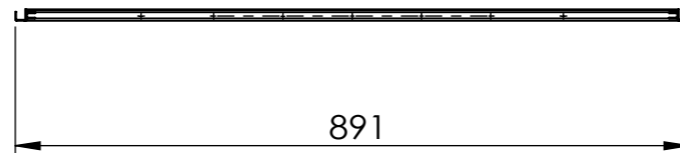
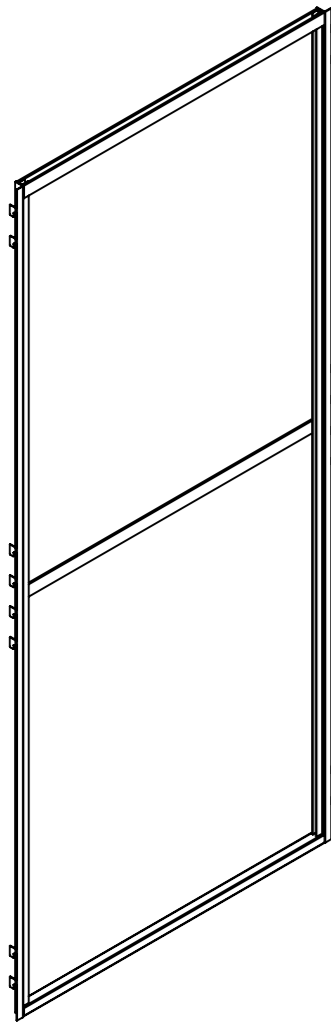

T 03 8787 3000 F 03 8787 3025  
 48-58 Cyber Loop, Dandenong South  
 VIC 3175 (AUSTRALIA)

© COPYRIGHT. This drawing is the exclusive property of Associated Projects Pty Ltd. It is subject to protection and is strictly confidential. Reproduction in whole or in part is prohibited without obtaining prior permission in writing from the proprietor.

Rev	Date	Description

ALL DIMENSIONS IN (mm)  
 UNLESS OTHERWISE SPECIFIED  
 BREAK ALL SHARP EDGES

TOLERANCES  
 (BEFORE PAINTING  
 & AFTER PLATING)  
 X ± 1.00  
 X.X ± 0.50  
 X.XX ± 0.10  
 ANGLES ± 0.5°

A03- -  
 CLIENT: -  
 PROJ. NO.: TBA  
 FINISH: P/C MATTE BLACK  
 MAT'L: MILD STEEL  
 Page 3

CLIP IN GRAPHIC FRAME - W900XH1380 - FOR CLIP IN GRAPHIC PANEL

PRODUCT CODE: **RFA2362**

Date: 30/10/2023

Drawn by DH

Checked by NP

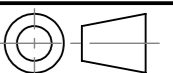

DO NOT SCALE

Scale@A3 1:10

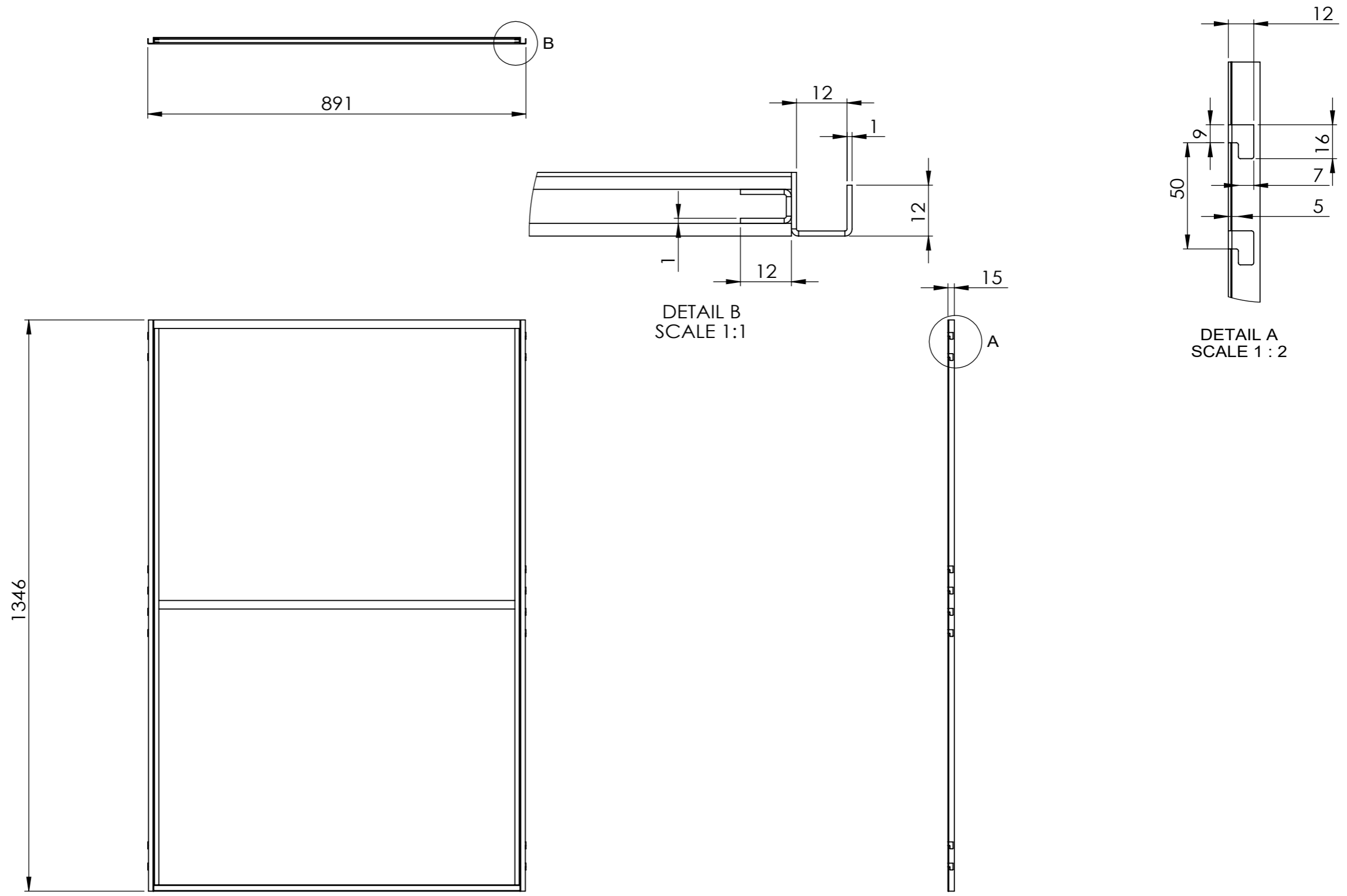

T 03 8787 3000 F 03 8787 3025  
 48-58 Cyber Loop, Dandenong South  
 VIC 3175 (AUSTRALIA)

© COPYRIGHT. This drawing is the exclusive property of Associated Projects Pty Ltd. It is subject to protection and is strictly confidential. Reproduction in whole or in part is prohibited without obtaining prior permission in writing from the proprietor.

Rev	Date	Description

ALL DIMENSIONS IN (mm)  
 UNLESS OTHERWISE SPECIFIED  
 BREAK ALL SHARP EDGES

TOLERANCES  
 (BEFORE PAINTING  
 & AFTER PLATING)  
 X ± 1.00  
 X.X ± 0.50  
 X.XX ± 0.10  
 ANGLES ± 0.5°

A04- -  
 CLIENT: -  
 PROJ. NO.: TBA  
 FINISH: P/C MATTE BLACK  
 MAT'L: MILD STEEL  
 Page 4

CLIP IN GRAPHIC FRAME - W900XH1380 - FOR CLIP IN GRAPHIC PANEL		
PRODUCT CODE: <b>RFA2362</b>		
Date:	30/10/2023	
Drawn by	DH	DO NOT SCALE
Checked by	NP	Scale@A3 1:10

ITEM NO.	QTY.	DESCRIPTION	LENGTH
1	1	LHS LUG PCS	
2	2	RHS LUG PCS	
3	1	INSERT GROOVE	
4	3	20 x 3 FB MILDSTEEL	862.4
5	1	CN SQ ERW 15 SQ 1.2	862.4

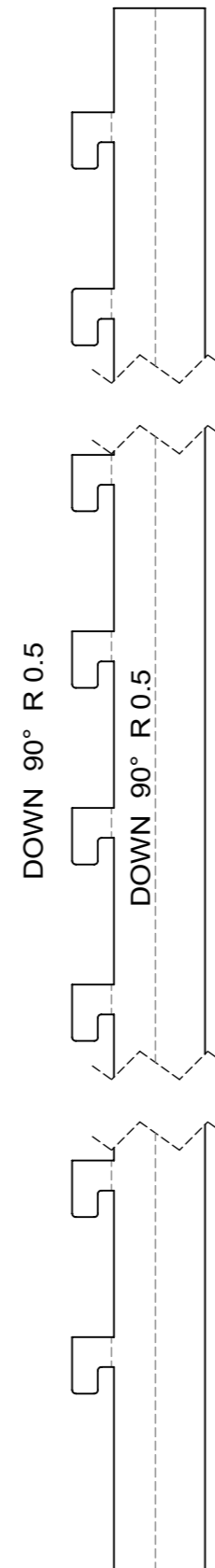
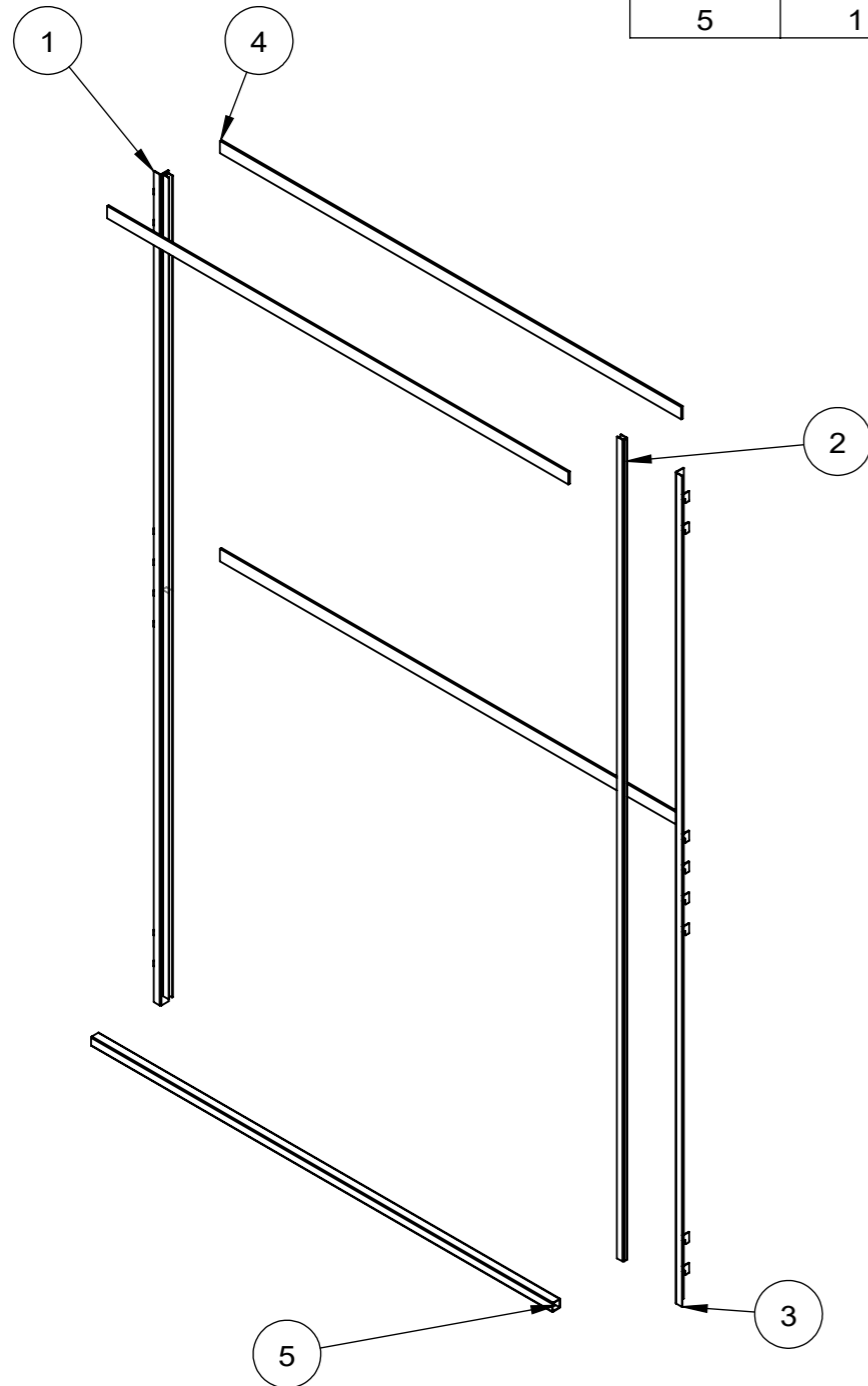

FLAT PATTERN:  
LHS LUG PCS  
SCALE 1:2

MATERIAL: MILD STEEL  
1.2 THK  
1645.5 L x 37.58 W  
↑↔GRN DIR

NOTE: LHS SHOWN; RHS AS MIRRORIED COPY



T 03 8787 3000 F 03 8787 3025  
48-58 Cyber Loop, Dandenong South  
VIC 3175 (AUSTRALIA)

© COPYRIGHT. This drawing is the exclusive property of Associated Projects Pty Ltd. It is subject to protection and is strictly confidential. Reproduction in whole or in part is prohibited without obtaining prior permission in writing from the proprietor.

Rev	Date	Description

ALL DIMENSIONS IN (mm)  
UNLESS OTHERWISE SPECIFIED  
BREAK ALL SHARP EDGES

TOLERANCES  
(BEFORE PAINTING  
& AFTER PLATING)  
X ± 1.00  
X.X ± 0.50  
X.XX ± 0.10  
ANGLES ± 0.5°

A05- -  
CLIENT: -  
PROJ. NO.: TBA  
FINISH: P/C MATTE BLACK  
MAT'L: MILD STEEL  
Page 5

CLIP IN GRAPHIC FRAME - W900XH1380 - FOR CLIP IN GRAPHIC PANEL

PRODUCT CODE: **RFA2362**

Date: 30/10/2023

Drawn by DH

Checked by NP

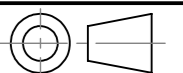

DO NOT SCALE

Scale@A3 1:1