



T 03 8787 3000 F 03 8787 3025
 48-58 Cyber Loop, Dandenong South
 VIC 3175 (AUSTRALIA)

© COPYRIGHT. This drawing is the exclusive property of Associated Projects Pty Ltd. It is subject to protection and is strictly confidential. Reproduction in whole or in part is prohibited without obtaining prior permission in writing from the proprietor.

Rev	Date	Description

ALL DIMENSIONS IN (mm)
 UNLESS OTHERWISE SPECIFIED
 BREAK ALL SHARP EDGES

TOLERANCES
 (BEFORE PAINTING
 & AFTER PLATING)
 X ± 1.00
 X.X ± 0.50
 X.XX ± 0.10
 ANGLES ± 0.5°

A01- -
 CLIENT: -
 PROJ. NO.: TBA
 FINISH: P/C MATTE BLACK
 MAT'L: MILD STEEL
 Page 1

CLIP IN GRAPHIC FRAME - W600XH1380 - FOR CLIP IN GRAPHIC PANEL

PRODUCT CODE: **RFA2361**

Date: 30/10/2023

Drawn by DH

Checked by NP

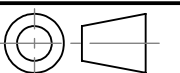

DO NOT SCALE

Scale@A3 1:1



RENDER WITH INSERTED ARTWORK



T 03 8787 3000 F 03 8787 3025
48-58 Cyber Loop, Dandenong South
VIC 3175 (AUSTRALIA)

© COPYRIGHT. This drawing is the exclusive property of Associated Projects Pty Ltd. It is subject to protection and is strictly confidential. Reproduction in whole or in part is prohibited without obtaining prior permission in writing from the proprietor.

Rev	Date	Description

ALL DIMENSIONS IN (mm)
UNLESS OTHERWISE SPECIFIED
BREAK ALL SHARP EDGES

TOLERANCES
(BEFORE PAINTING
& AFTER PLATING)
X ± 1.00
X.X ± 0.50
X.XX ± 0.10
ANGLES ± 0.5°

A02- RENDER
CLIENT: -
PROJ. NO.: TBA
FINISH: P/C MATTE BLACK
MAT'L: MILD STEEL
Page 2

CLIP IN GRAPHIC FRAME - W600XH1380 - FOR CLIP IN GRAPHIC PANEL

PRODUCT CODE: RFA2361		
Date:	30/10/2023	
Drawn by	DH	DO NOT SCALE
Checked by	NP	Scale@A3 1:1

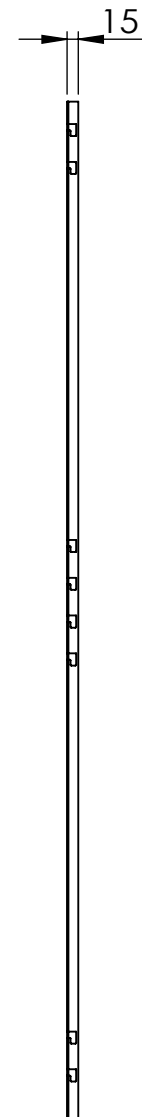
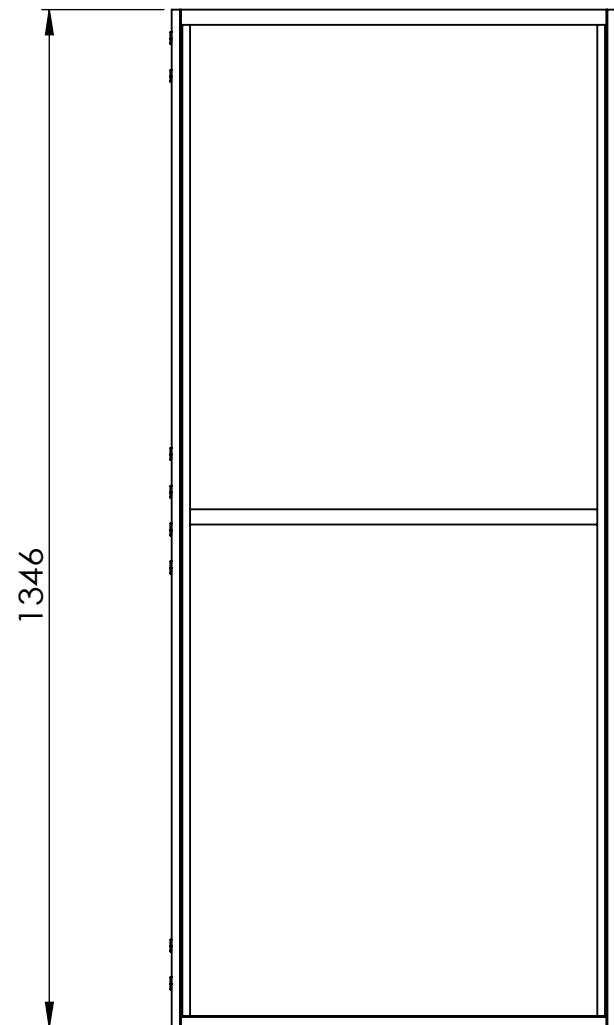
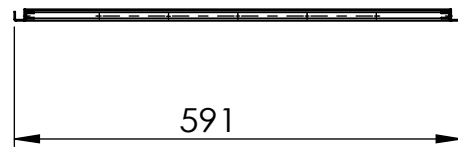
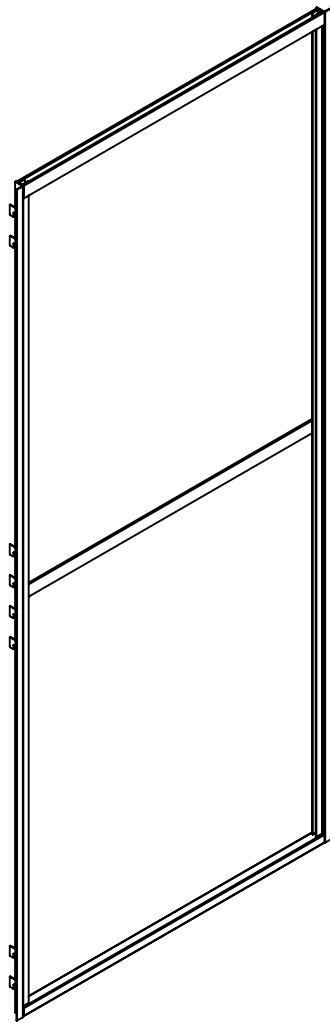

T 03 8787 3000 F 03 8787 3025
48-58 Cyber Loop, Dandenong South
VIC 3175 (AUSTRALIA)

© COPYRIGHT. This drawing is the exclusive property of Associated Projects Pty Ltd. It is subject to protection and is strictly confidential. Reproduction in whole or in part is prohibited without obtaining prior permission in writing from the proprietor.

Rev	Date	Description

ALL DIMENSIONS IN (mm)
UNLESS OTHERWISE SPECIFIED
BREAK ALL SHARP EDGES

TOLERANCES
(BEFORE PAINTING
& AFTER PLATING)
X ± 1.00
X.X ± 0.50
X.XX ± 0.10
ANGLES ± 0.5°

A03- -
CLIENT: -
PROJ. NO.: TBA
FINISH: P/C MATTE BLACK
MAT'L: MILD STEEL
Page 3

CLIP IN GRAPHIC FRAME - W600XH1380 - FOR CLIP IN GRAPHIC PANEL

PRODUCT CODE: **RFA2361**

Date: 30/10/2023

Drawn by DH

Checked by NP

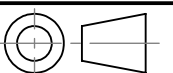

DO NOT SCALE

Scale@A3 1:10

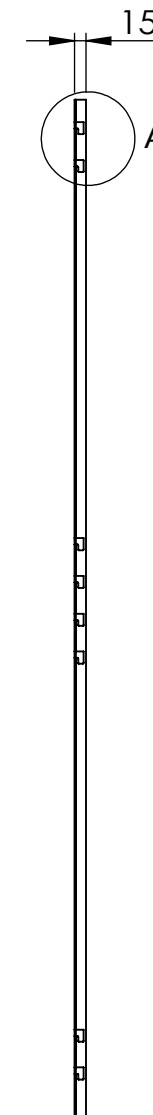
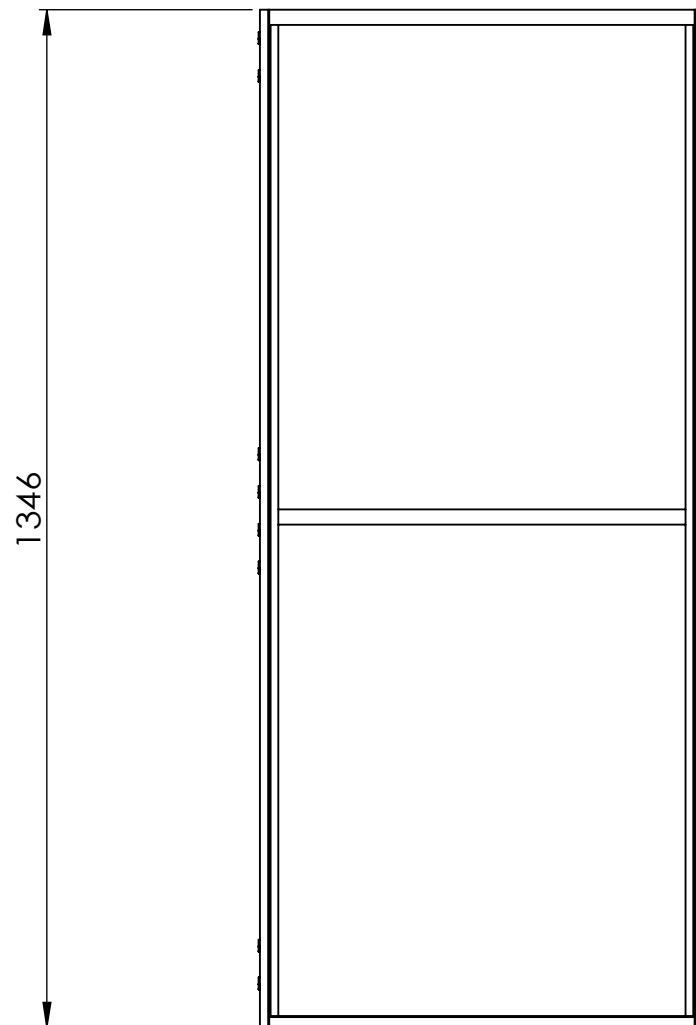
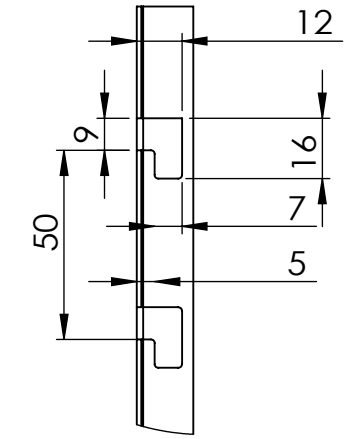
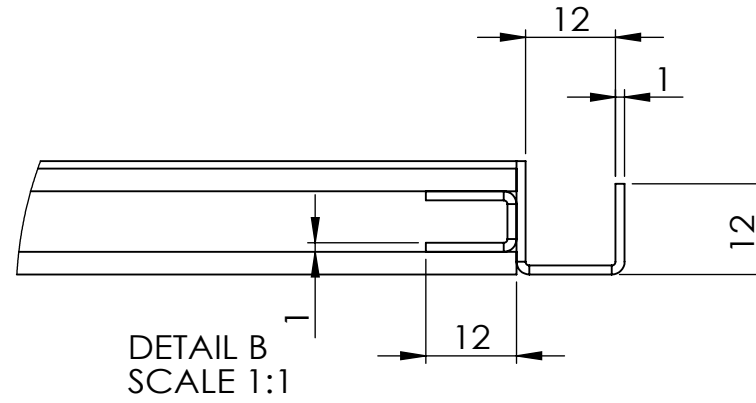
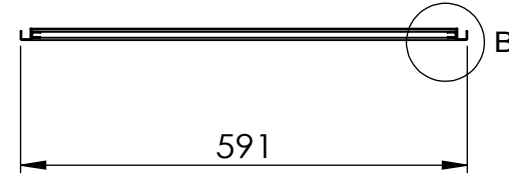

T 03 8787 3000 F 03 8787 3025
48-58 Cyber Loop, Dandenong South
VIC 3175 (AUSTRALIA)

© COPYRIGHT. This drawing is the exclusive property of Associated Projects Pty Ltd. It is subject to protection and is strictly confidential. Reproduction in whole or in part is prohibited without obtaining prior permission in writing from the proprietor.

Rev	Date	Description

ALL DIMENSIONS IN (mm)
UNLESS OTHERWISE SPECIFIED
BREAK ALL SHARP EDGES

TOLERANCES
(BEFORE PAINTING
& AFTER PLATING)
X ± 1.00
X.X ± 0.50
X.XX ± 0.10
ANGLES ± 0.5°

A04- -
CLIENT: -
PROJ. NO.: TBA
FINISH: P/C MATTE BLACK
MAT'L: MILD STEEL
Page 4

CLIP IN GRAPHIC FRAME - W600XH1380 - FOR CLIP IN GRAPHIC PANEL

PRODUCT CODE: **RFA2361**

Date: 30/10/2023

Drawn by DH

Checked by NP

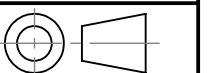

DO NOT SCALE

Scale@A3 1:10

ITEM NO.	QTY.	DESCRIPTION	LENGTH
1	1	LHS LUG PCS	
2	2	RHS LUG PCS	
3	1	INSERT GROOVE	
4	3	20 x 3 FB MILDSTEEL	862.4
5	1	CN SQ ERW 15 SQ 1.2	862.4

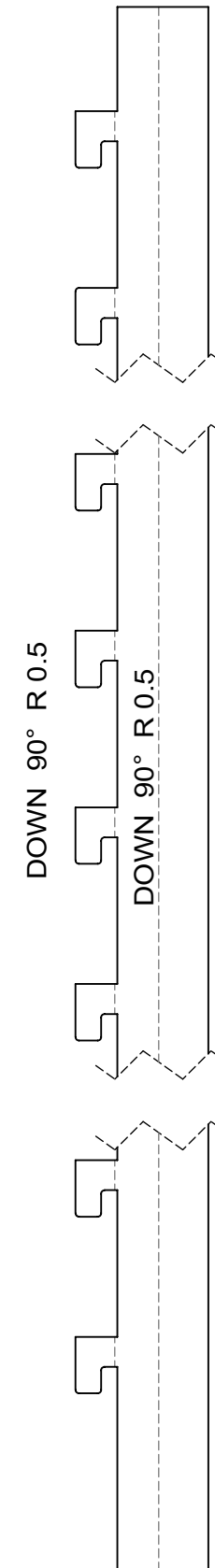
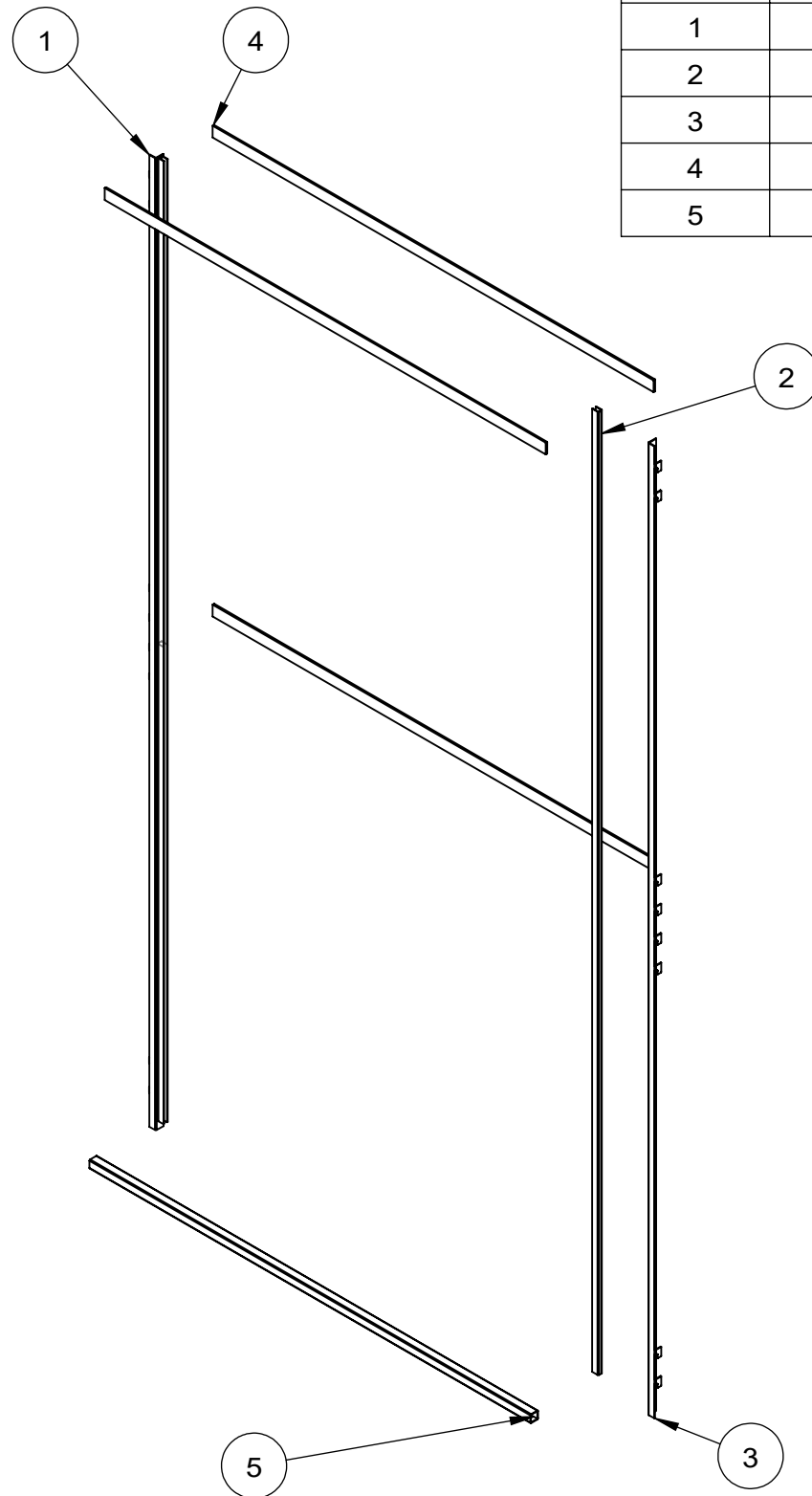

FLAT PATTERN:
LHS LUG PCS
SCALE 1:2

MATERIAL: MILD STEEL
1.2 THK
1645.5 L x 37.58 W
↑↔GRN DIR

NOTE: LHS SHOWN; RHS AS
MIRRORIED COPY



T 03 8787 3000 F 03 8787 3025
48-58 Cyber Loop, Dandenong South
VIC 3175 (AUSTRALIA)

© COPYRIGHT. This drawing is the exclusive property of Associated Projects Pty Ltd. It is subject to protection and is strictly confidential. Reproduction in whole or in part is prohibited without obtaining prior permission in writing from the proprietor.

Rev	Date	Description

ALL DIMENSIONS IN (mm)
UNLESS OTHERWISE SPECIFIED
BREAK ALL SHARP EDGES

TOLERANCES
(BEFORE PAINTING
& AFTER PLATING)
X ± 1.00
X.X ± 0.50
X.XX ± 0.10
ANGLES ± 0.5°

A05- -
CLIENT: -
PROJ. NO.: TBA
FINISH: P/C MATTE BLACK
MAT'L: MILD STEEL
Page 5

CLIP IN GRAPHIC FRAME - W600XH1380 - FOR CLIP
IN GRAPHIC PANEL

PRODUCT CODE: **RFA2361**

Date: 30/10/2023

Drawn by DH

Checked by NP

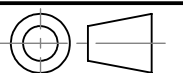

DO NOT SCALE

Scale@A3 1:1