

T 03 8787 3000 F 03 8787 3025  
 48-58 Cyber Loop, Dandenong South  
 VIC 3175 (AUSTRALIA)

© COPYRIGHT. This drawing is the exclusive property of Associated Projects Pty Ltd. It is subject to protection and is strictly confidential. Reproduction in whole or in part is prohibited without obtaining prior permission in writing from the proprietor.

Rev	Date	Description

ALL DIMENSIONS IN (mm)  
 UNLESS OTHERWISE SPECIFIED  
 BREAK ALL SHARP EDGES

TOLERANCES  
 (BEFORE PAINTING  
 & AFTER PLATING)  
 X ± 1.00  
 X.X ± 0.50  
 X.XX ± 0.10  
 ANGLES ± 0.5°

A01- RENDER  
 CLIENT: -  
 PROJ. NO.: TBA  
 FINISH: P/C MATTE BLACK  
 MAT'L: MILD STEEL  
 Page 1

SIGNAGE SUPPORT (SLIDER) BRACKET - W600 - TOP BRACKET

PRODUCT CODE: **RFA2324**

Date: 2/10/2023

Drawn by DH

Checked by NP

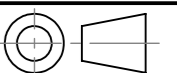

DO NOT SCALE

Scale@A3 1:1

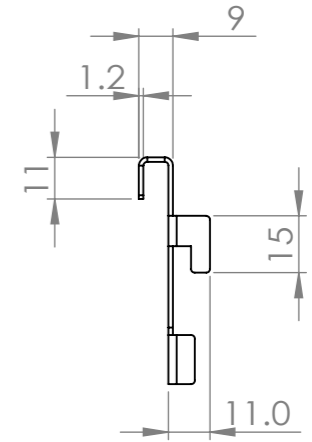
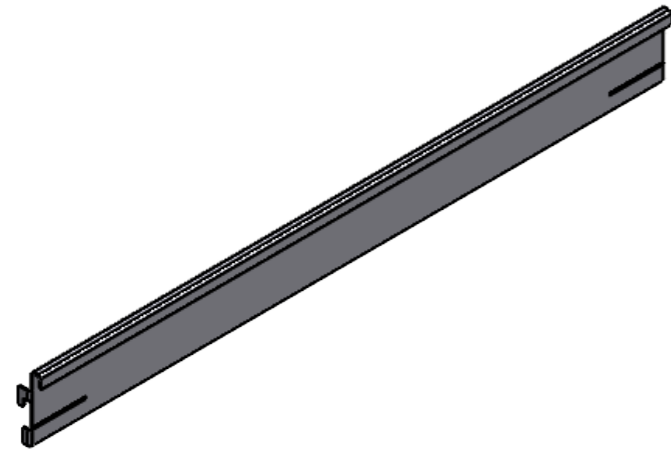

DETAIL U  
SCALE 1 : 2

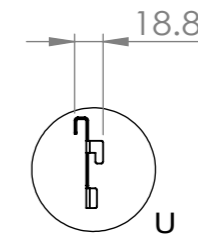
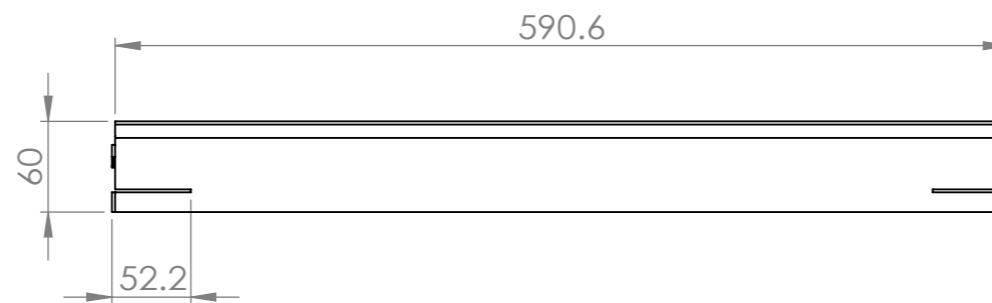
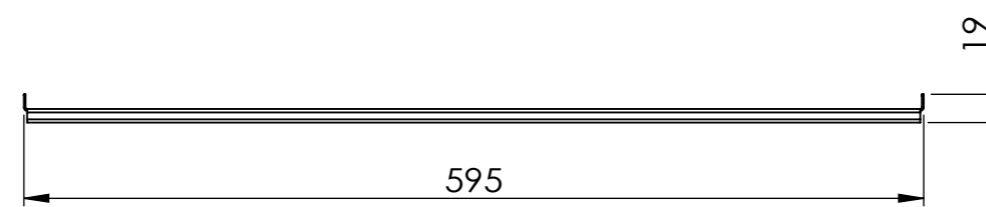

T 03 8787 3000 F 03 8787 3025  
48-58 Cyber Loop, Dandenong South  
VIC 3175 (AUSTRALIA)

© COPYRIGHT. This drawing is the exclusive property of Associated Projects Pty Ltd. It is subject to protection and is strictly confidential. Reproduction in whole or in part is prohibited without obtaining prior permission in writing from the proprietor.

Rev	Date	Description

ALL DIMENSIONS IN (mm)  
UNLESS OTHERWISE SPECIFIED  
BREAK ALL SHARP EDGES

TOLERANCES  
(BEFORE PAINTING  
& AFTER PLATING)  
X ± 1.00  
X.X ± 0.50  
X.XX ± 0.10  
ANGLES ± 0.5°

A02- CLIENT

CLIENT: -

PROJ. NO.: TBA

FINISH: P/C MATTE BLACK

MAT'L: MILD STEEL

Page 2

SIGNAGE SUPPORT (SLIDER) BRACKET - W600 - TOP BRACKET

PRODUCT CODE: **RFA2324**

Date: 2/10/2023

Drawn by DH

Checked by NP

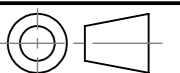

DO NOT SCALE

Scale@A3 1:5