



FINISH: P/C MATTE BLACK

AP ASSOCIATED PROJECTS COMMERCIAL BUILDERS,
PROJECT MANAGERS,
PLANNERS & DESIGNERS

T 03 8787 3000 F 03 8787 3025
48-58 Cyber Loop, Dandenong South VIC 3175

Rev	Date	Description

ALL DIMENSIONS IN (mm)
UNLESS OTHERWISE SPECIFIED
BREAK ALL SHARP EDGES

TOLERANCES
(BEFORE PAINTING
& AFTER PLATING)
X ± 1.00
X.X ± 0.50
X.XX ± 0.10
ANGLES ± 0.5°

A01- RENDER

CLIENT: RFA

PROJ. NO.: TBA

PART NO.: --

Revision --

Page 1

ADD BAY - WALL BAY - MODULAR - SLAT WALL
W1200 x H2400

PRODUCT CODE: **RFA2195**

Date: 16/07/2024

Drawn by PS

Checked by --

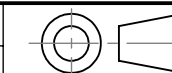

DO NOT SCALE

Scale@A3 1:20

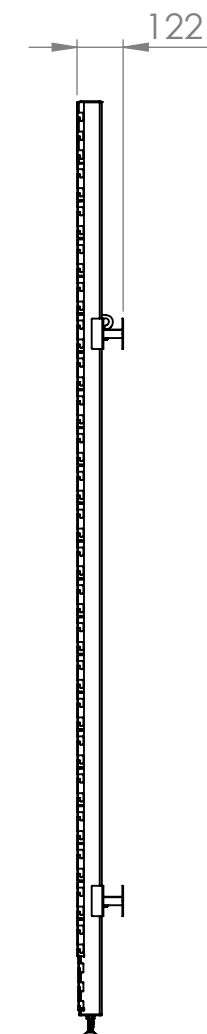
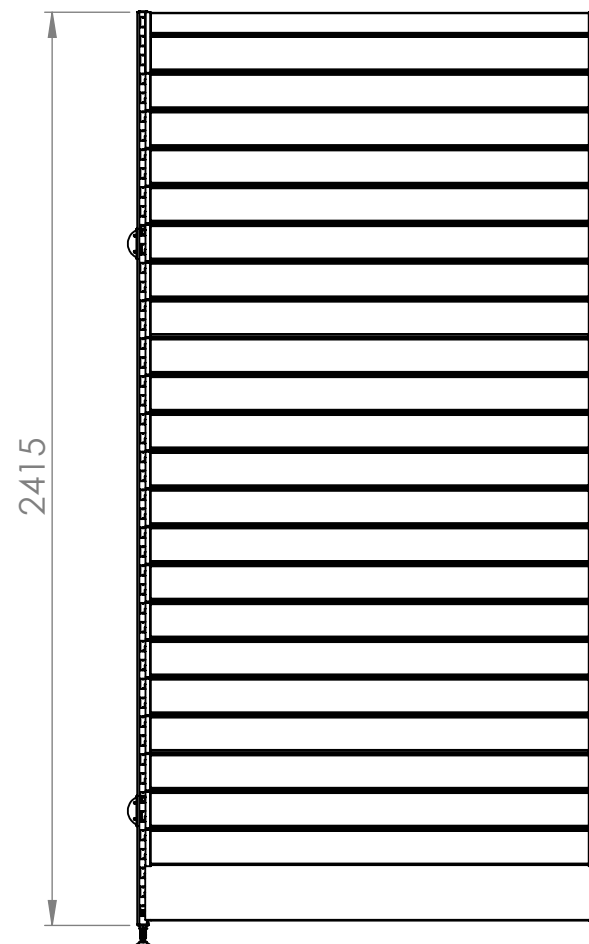
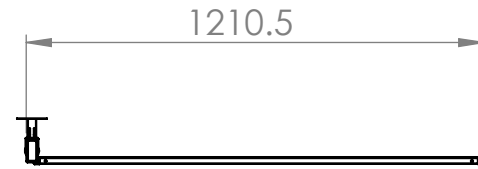
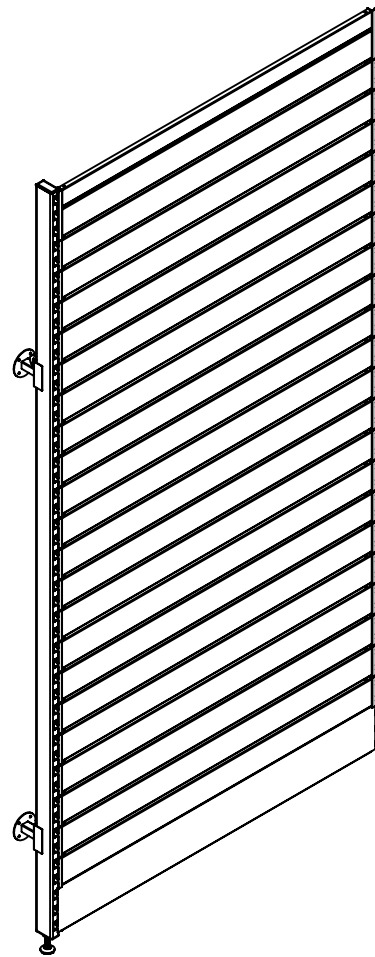

Rev	Date	Description

ALL DIMENSIONS IN (mm)
UNLESS OTHERWISE SPECIFIED
BREAK ALL SHARP EDGES

TOLERANCES
(BEFORE PAINTING
& AFTER PLATING)
X ± 1.00
X.X ± 0.50
X.XX ± 0.10
ANGLES ± 0.5°

A02- DIMENSIONS

CLIENT: RFA
PROJ. NO.: TBA
PART NO.: --
Revision --
Page 2

ADD BAY - WALL BAY - MODULAR - SLAT WALL
W1200 x H2400

PRODUCT CODE: **RFA2195**

Date: 16/07/2024

Drawn by PS

Checked by --

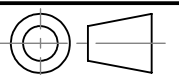

DO NOT SCALE

Scale@A3 1:20

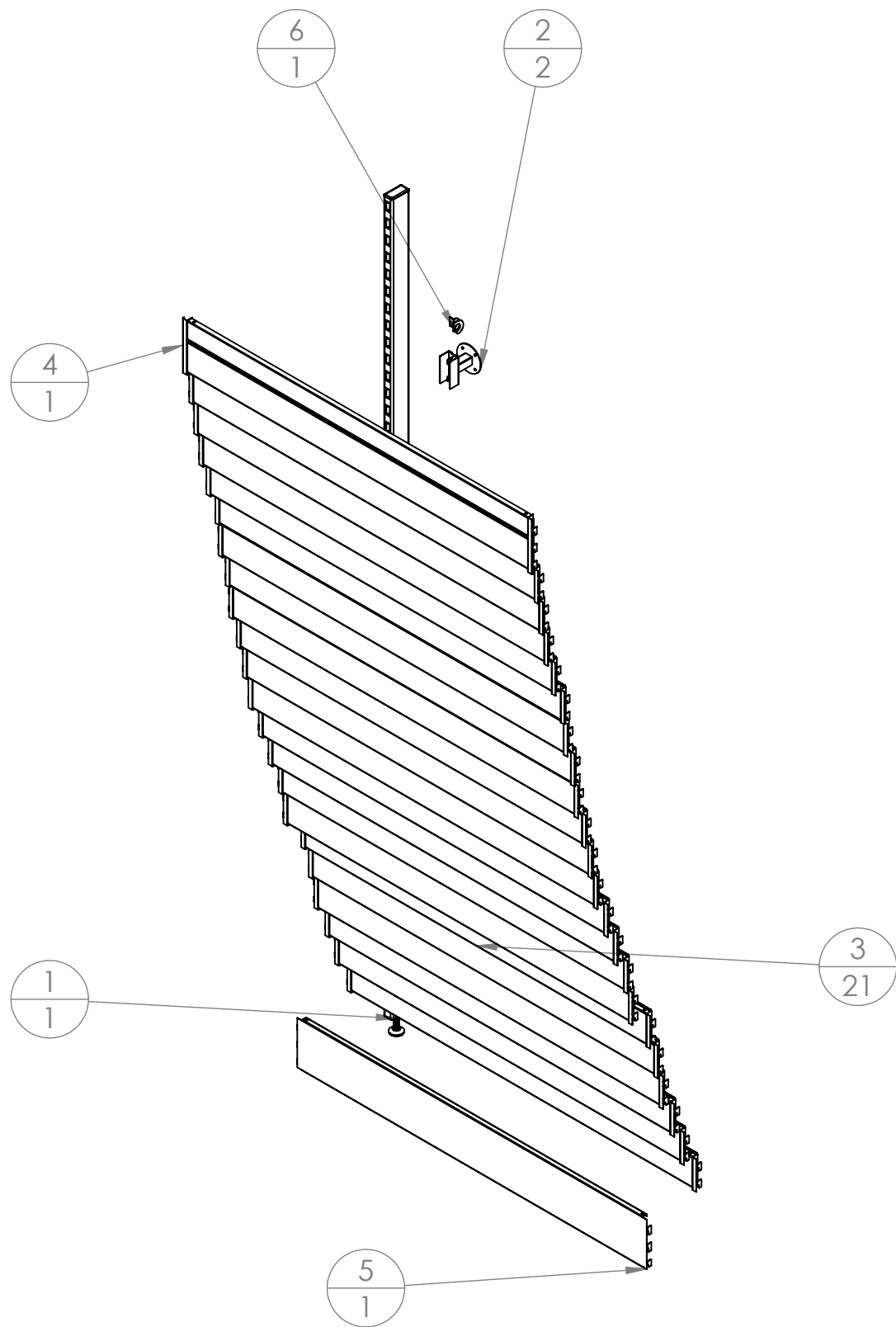

ITEM NO.	PartNo	DESCRIPTION	QTY.
1	RFA2300	2400mm(H) MID PANEL POST	1
2	RFA2301	POST SUPPORT BRACKET D50-90	2
3	RFA2317	CLIP IN PANEL - W1200XH100 - SLAT WALL	21
4	RFA2320	1200mm(W)x150mm(H) SLAT PANEL	1
5	RFA2323	1200W X 150H SKIRT	1
6		SAFETY LOCK IN POST CLIP	1

Rev	Date	Description

ALL DIMENSIONS IN (mm)
UNLESS OTHERWISE SPECIFIED
BREAK ALL SHARP EDGES

TOLERANCES
(BEFORE PAINTING
& AFTER PLATING)
X ± 1.00
X.X ± 0.50
X.XX ± 0.10
ANGLES ± 0.5°

A03- EXPLODED

CLIENT: RFA

PROJ. NO.: TBA

PART NO.: --

Revision --

Page 3

ADD BAY - WALL BAY - MODULAR - SLAT WALL
W1200 x H2400

PRODUCT CODE: **RFA2195**

Date: 16/07/2024

Drawn by PS

Checked by --

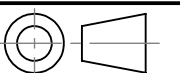

DO NOT SCALE

Scale@A3 1:20