



FINISH: P/C MATTE BLACK

**AP ASSOCIATED PROJECTS** COMMERCIAL BUILDERS,  
PROJECT MANAGERS,  
PLANNERS & DESIGNERS

T 03 8787 3000 F 03 8787 3025  
48-58 Cyber Loop, Dandenong South VIC 3175

Rev	Date	Description

ALL DIMENSIONS IN (mm)  
UNLESS OTHERWISE SPECIFIED  
BREAK ALL SHARP EDGES

TOLERANCES  
(BEFORE PAINTING  
& AFTER PLATING)  
X ± 1.00  
X.X ± 0.50  
X.XX ± 0.10  
ANGLES ± 0.5°

A01- RENDER  
CLIENT: RFA  
PROJ. NO.: TBA  
PART NO.: --  
Revision --  
Page 1

ADD BAY - WALL BAY - MODULAR - SLAT WALL W600 x H2400		
PRODUCT CODE: <b>RFA2191</b>		
Date: 12/07/2024	PS	DO NOT SCALE
Drawn by	--	Scale@A3 1:20
Checked by	--	

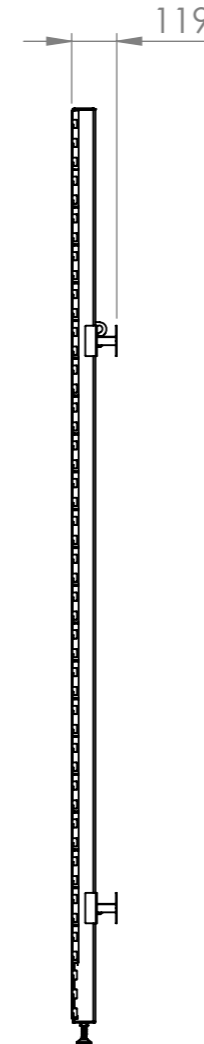
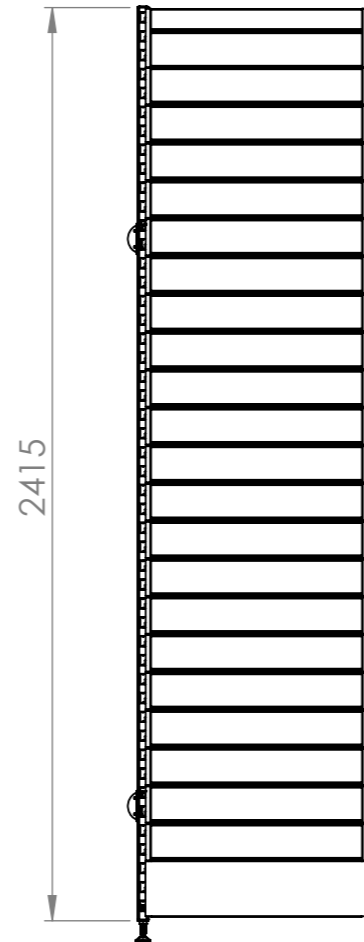
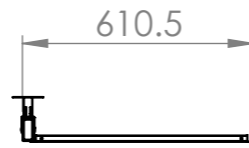
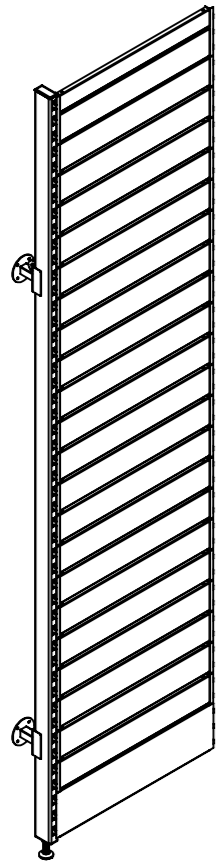

Rev	Date	Description

ALL DIMENSIONS IN (mm)  
UNLESS OTHERWISE SPECIFIED  
BREAK ALL SHARP EDGES

TOLERANCES  
(BEFORE PAINTING  
& AFTER PLATING)  
X ± 1.00  
X.X ± 0.50  
X.XX ± 0.10  
ANGLES ± 0.5°

**A02- DIMENSIONS**

CLIENT: RFA  
PROJ. NO.: TBA  
PART NO.: --  
Revision --  
Page 2

ADD BAY - WALL BAY - MODULAR - SLAT WALL  
W600 x H2400

PRODUCT CODE: **RFA2191**

Date: 12/07/2024

Drawn by PS

Checked by --

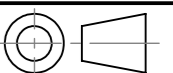

DO NOT SCALE

Scale@A3 1:20

ITEM NO.	PartNo	DESCRIPTION	QTY.
1	RFA2300	2400mm(H) MID PANEL POST	1
2	RFA2301	POST SUPPORT BRACKET D50-90	2
3	RFA2315	CLIP IN PANEL - W600XH100 - SLAT WALL	21
4	RFA2318	CLIP IN PANEL-W600xH150- SLAT PANEL	1
5	RFA2321	W600 X H150 SKIRT	1
6		SAFETY LOCK IN POST CLIP	1

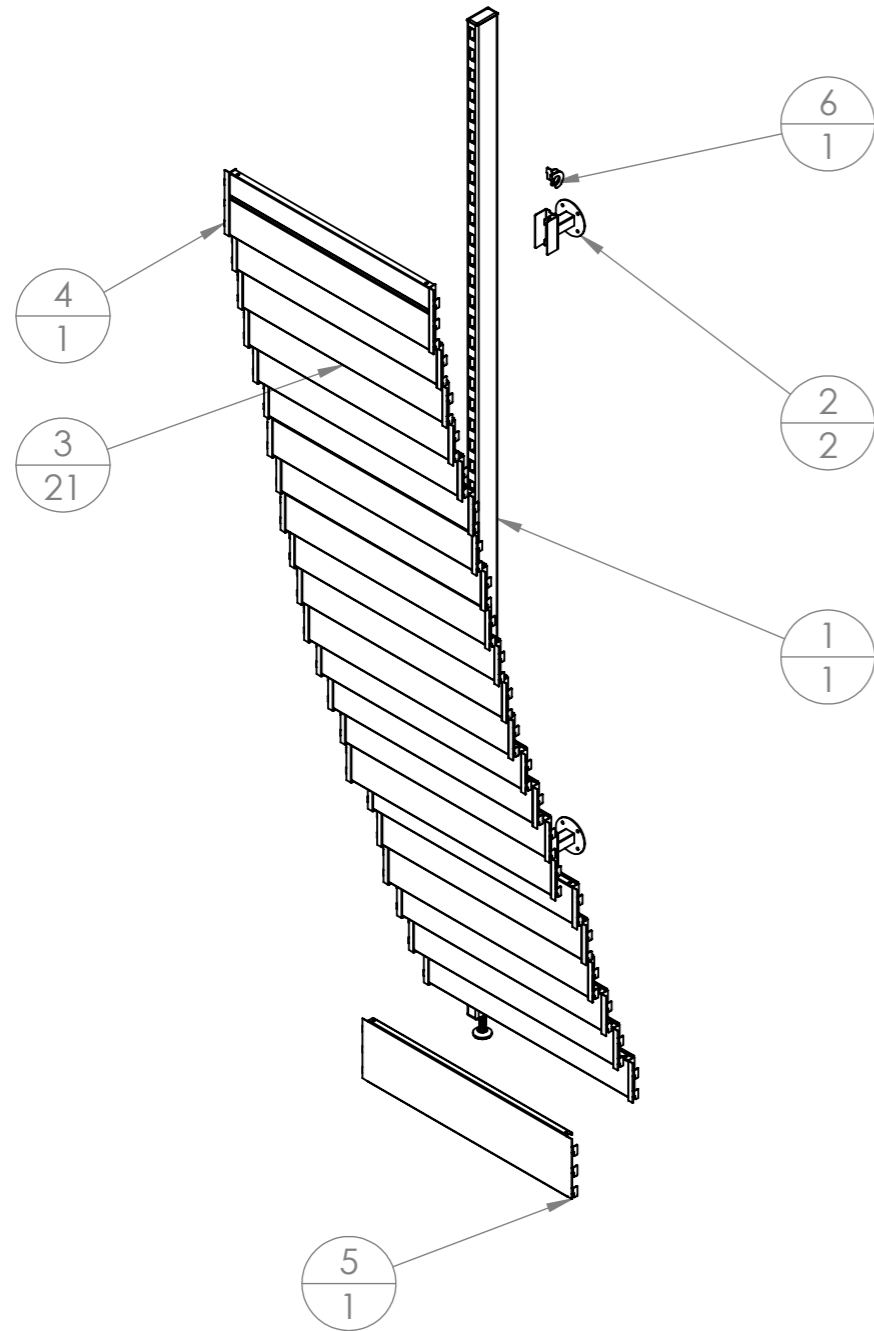

Rev	Date	Description

ALL DIMENSIONS IN (mm)  
UNLESS OTHERWISE SPECIFIED  
BREAK ALL SHARP EDGES

TOLERANCES  
(BEFORE PAINTING  
& AFTER PLATING)  
X ± 1.00  
X.X ± 0.50  
X.XX ± 0.10  
ANGLES ± 0.5°

A03- EXPLODED

CLIENT: RFA

PROJ. NO.: TBA

PART NO.: --

Revision --

Page 3

ADD BAY - WALL BAY - MODULAR - SLAT WALL  
W600 x H2400

PRODUCT CODE: **RFA2191**

Date: 12/07/2024

Drawn by PS

Checked by --

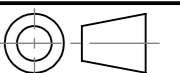

DO NOT SCALE

Scale@A3 1:20