

FINISH: P/C MATTE BLACK

AP ASSOCIATED PROJECTS COMMERCIAL BUILDERS,
PROJECT MANAGERS,
PLANNERS & DESIGNERS

T 03 8787 3000 F 03 8787 3025
48-58 Cyber Loop, Dandenong South VIC 3175

| Rev | Date | Description |
|-----|------|-------------|
| | | |
| | | |
| | | |
| | | |

ALL DIMENSIONS IN (mm)
UNLESS OTHERWISE SPECIFIED
BREAK ALL SHARP EDGES

TOLERANCES
(BEFORE PAINTING
& AFTER PLATING)
X ± 1.00
X.X ± 0.50
X.XX ± 0.10
ANGLES ± 0.5°

A01- RENDER

CLIENT: RFA

PROJ. NO.: TBA

PART NO.: --

Revision --

Page 1

START BAY - WALL BAY _ MODULAR - NON PERF
W1200 x H2400

PRODUCT CODE: RFA2188

Date: 12/07/2024

Drawn by PS

Checked by --

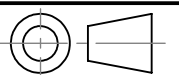

DO NOT SCALE

Scale@A3 1:20

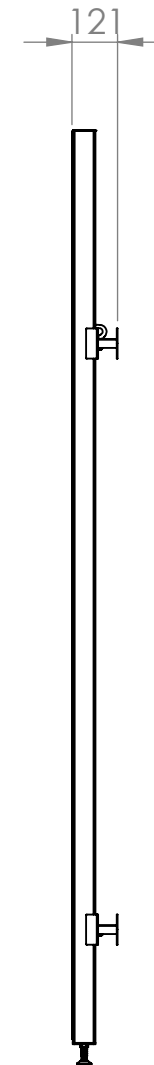
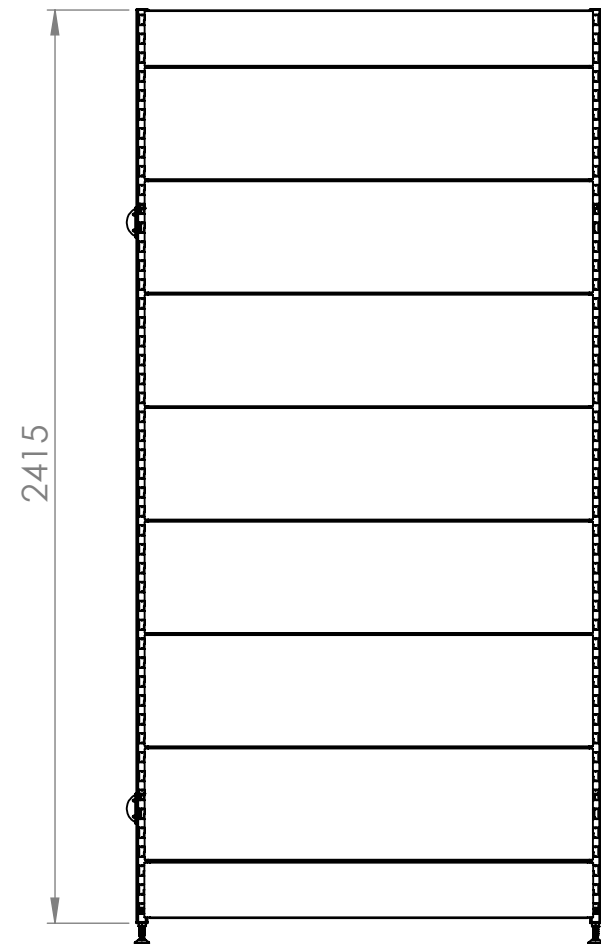
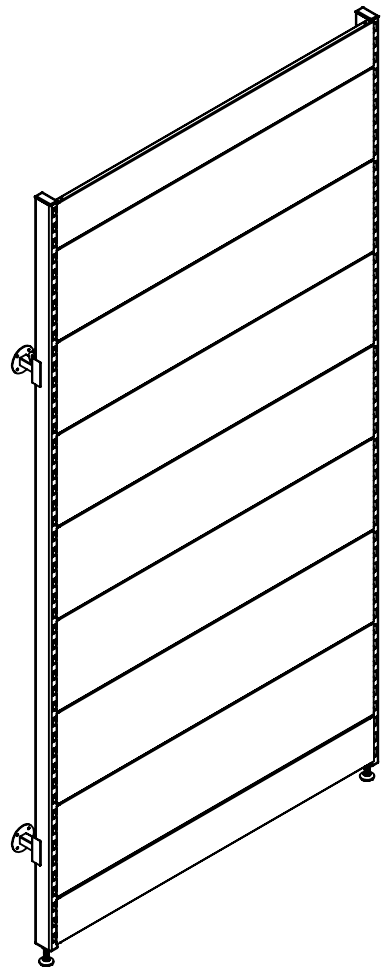

| Rev | Date | Description |
|-----|------|-------------|
| | | |
| | | |
| | | |

ALL DIMENSIONS IN (mm)
UNLESS OTHERWISE SPECIFIED
BREAK ALL SHARP EDGES

TOLERANCES
(BEFORE PAINTING
& AFTER PLATING)
X ± 1.00
X.X ± 0.50
X.XX ± 0.10
ANGLES ± 0.5°

A02- DIMENSIONS

CLIENT: RFA
PROJ. NO.: TBA
PART NO.: --
Revision --
Page 2

START BAY - WALL BAY _ MODULAR - NON PERF
W1200 x H2400

PRODUCT CODE: **RFA2188**

Date: 12/07/2024

Drawn by PS

Checked by --

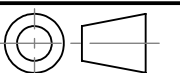

DO NOT SCALE

Scale@A3 1:20

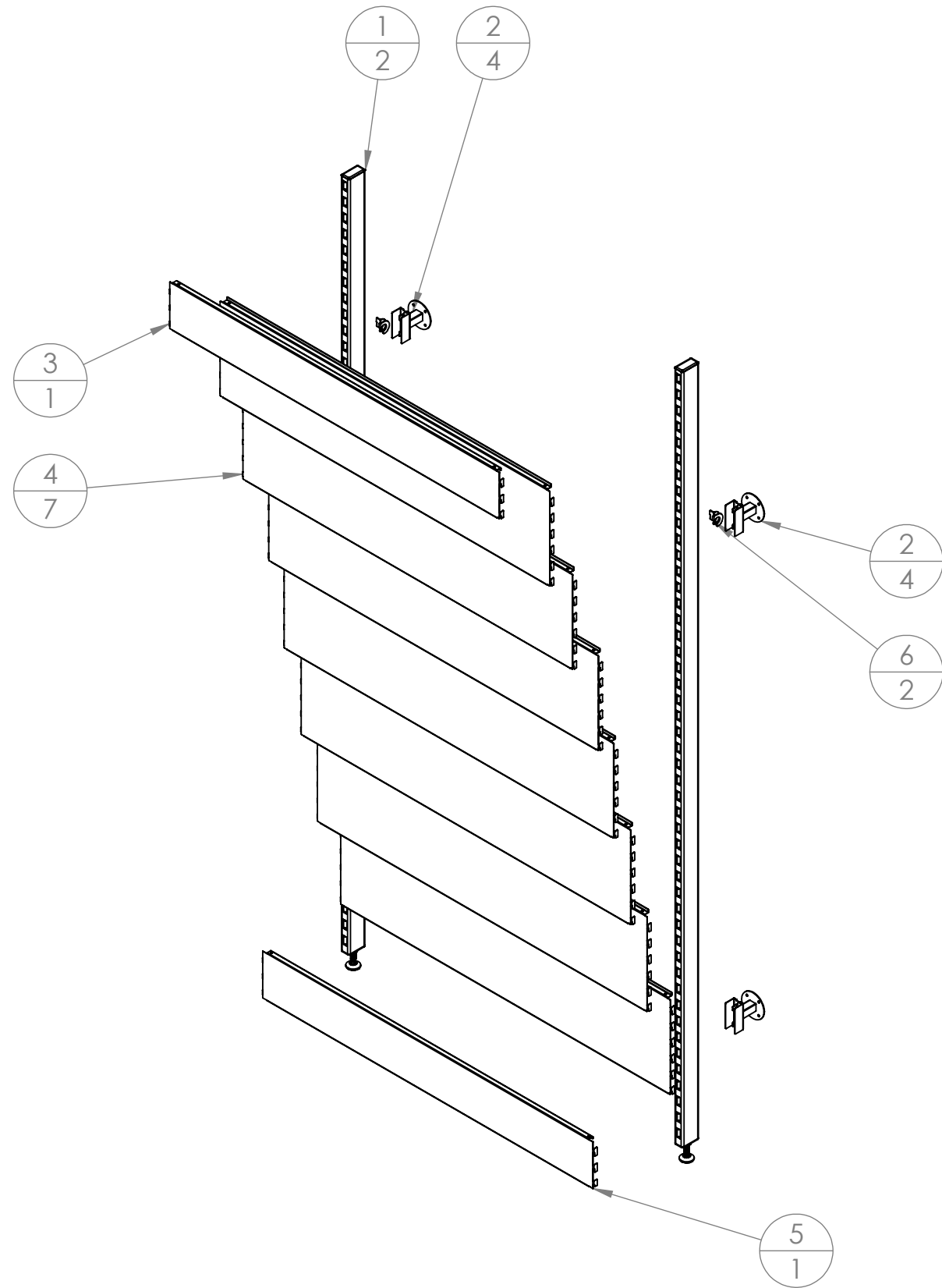

| ITEM NO. | PartNo | DESCRIPTION | QTY. |
|----------|---------|--|------|
| 1 | RFA2300 | 2400mm(H) MID PANEL POST | 2 |
| 2 | RFA2301 | POST SUPPORT BRACKET D50-90 | 4 |
| 3 | RFA2311 | W1200xH150 NON PERFORATED CLIP IN PANEL | 1 |
| 4 | RFA2314 | W1200 xH300 NON PERFORATED CLIP IN PANEL | 7 |
| 5 | RFA2323 | 1200W X 150H SKIRT | 1 |
| 6 | | SAFETY LOCK IN POST CLIP | 2 |

| Rev | Date | Description |
|-----|------|-------------|
| | | |
| | | |
| | | |

ALL DIMENSIONS IN (mm)
 UNLESS OTHERWISE SPECIFIED
 BREAK ALL SHARP EDGES

TOLERANCES
 (BEFORE PAINTING
 & AFTER PLATING)
 X ± 1.00
 X.X ± 0.50
 X.XX ± 0.10
 ANGLES ± 0.5°

A03- EXPLODED
 CLIENT: RFA
 PROJ. NO.: TBA
 PART NO.: --
 Revision --
 Page 3

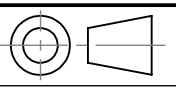
| | | |
|---|------------------|---|
| START BAY - WALL BAY_ MODULAR - NON PERF W1200 x H2400 | |  DO NOT SCALE |
| PRODUCT CODE: RFA2188 | Date: 12/07/2024 | |
| Drawn by PS | Checked by -- | Scale@A3 1:20 |