



T 03 8787 3000 F 03 8787 3025
 48-58 Cyber Loop, Dandenong South
 VIC 3175 (AUSTRALIA)

© COPYRIGHT. This drawing is the exclusive property of Associated Projects Pty Ltd. It is subject to protection and is strictly confidential. Reproduction in whole or in part is prohibited without obtaining prior permission in writing from the proprietor.

Rev	Date	Description

ALL DIMENSIONS IN (mm)
 UNLESS OTHERWISE SPECIFIED
 BREAK ALL SHARP EDGES

TOLERANCES
 (BEFORE PAINTING
 & AFTER PLATING)
 X ± 1.00
 X.X ± 0.50
 X.XX ± 0.10
 ANGLES ± 0.5°

A01- RENDER
CLIENT: RFA
PROJ. NO.: TBA
FINISH: CUSTOMISED
MAT'L: MILD STEEL
Page 1

**PELMET COVER - W900XH200 - CUSTOM COLOUR
 (TO SUIT CLIENT)**

PRODUCT CODE: RFA2148

Date: 1/11/2023

Drawn by PS

Checked by NP

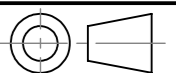

DO NOT SCALE

Scale@A3 1:5

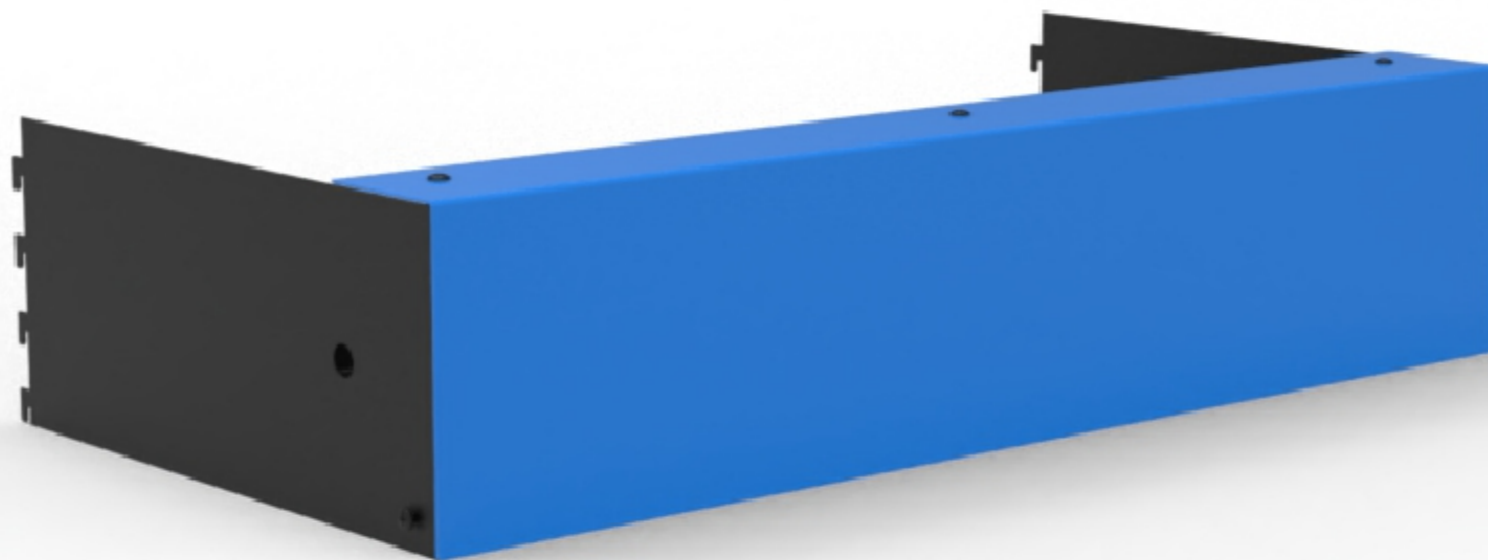

RENER WITH PELMET BOX



T 03 8787 3000 F 03 8787 3025
 48-58 Cyber Loop, Dandenong South
 VIC 3175 (AUSTRALIA)

© COPYRIGHT. This drawing is the exclusive property of Associated Projects Pty Ltd. It is subject to protection and is strictly confidential. Reproduction in whole or in part is prohibited without obtaining prior permission in writing from the proprietor.

Rev	Date	Description

ALL DIMENSIONS IN (mm)
 UNLESS OTHERWISE SPECIFIED
 BREAK ALL SHARP EDGES

TOLERANCES
 (BEFORE PAINTING
 & AFTER PLATING)
 X ± 1.00
 X.X ± 0.50
 X.XX ± 0.10
 ANGLES ± 0.5°

A02- RENDER

CLIENT: RFA

PROJ. NO.: TBA

FINISH: CUSTOMISED

MAT'L: MILD STEEL

Page 2

PELMET COVER - W900XH200 - CUSTOM COLOUR
 (TO SUIT CLIENT)

PRODUCT CODE: **RFA2148**

Date: 1/11/2023

Drawn by PS

Checked by NP

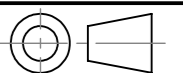

DO NOT SCALE

Scale@A3 1:10

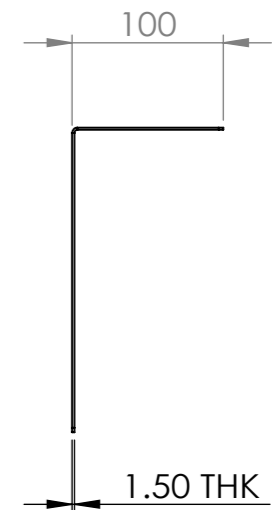
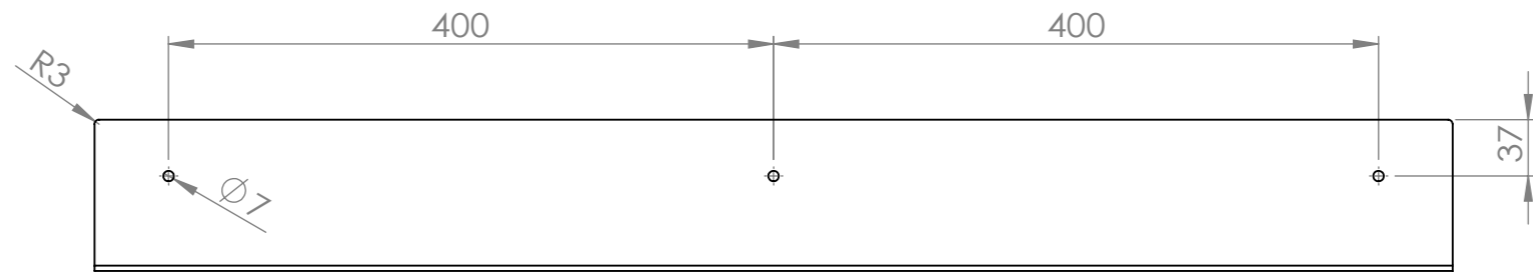
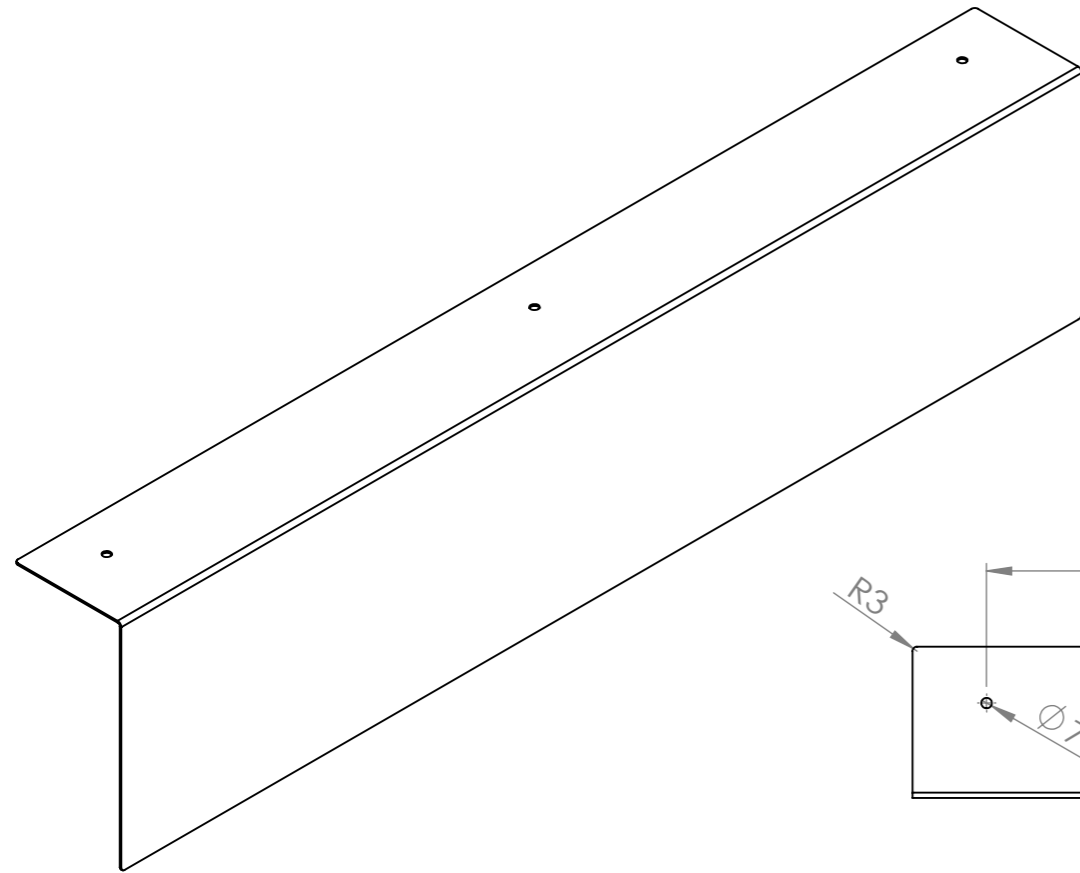

T 03 8787 3000 F 03 8787 3025
48-58 Cyber Loop, Dandenong South
VIC 3175 (AUSTRALIA)

© COPYRIGHT. This drawing is the exclusive property of Associated Projects Pty Ltd. It is subject to protection and is strictly confidential. Reproduction in whole or in part is prohibited without obtaining prior permission in writing from the proprietor.

Rev	Date	Description

ALL DIMENSIONS IN (mm)
UNLESS OTHERWISE SPECIFIED
BREAK ALL SHARP EDGES

TOLERANCES
(BEFORE PAINTING
& AFTER PLATING)
X ± 1.00
X.X ± 0.50
X.XX ± 0.10
ANGLES ± 0.5°

A03- -
CLIENT: RFA
PROJ. NO.: TBA
FINISH: CUSTOMISED
MAT'L: MILD STEEL
Page 3

PELMET COVER - W900XH200 - CUSTOM COLOUR
(TO SUIT CLIENT)

PRODUCT CODE: **RFA2148**

Date: 1/11/2023

Drawn by PS

Checked by NP

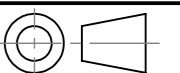

DO NOT SCALE

Scale@A3 1:5

ITEM NO.	PRODUCT CODE	DESCRIPTION	FINISH	QTY.
1	RFA2145	PELMET - W900XH200XD450 - CLIPS INTO POSTS	P/C MATTE BLACK	1
2	RFA2148	PELMET COVER - W900XH200 - CUSTOM COLOUR (TO SUIT CLIENT)	CUSTOMISED	1
3		M6 x 16mm BUTTON HEAD SCREW		5
4		M6 WING NUT		5

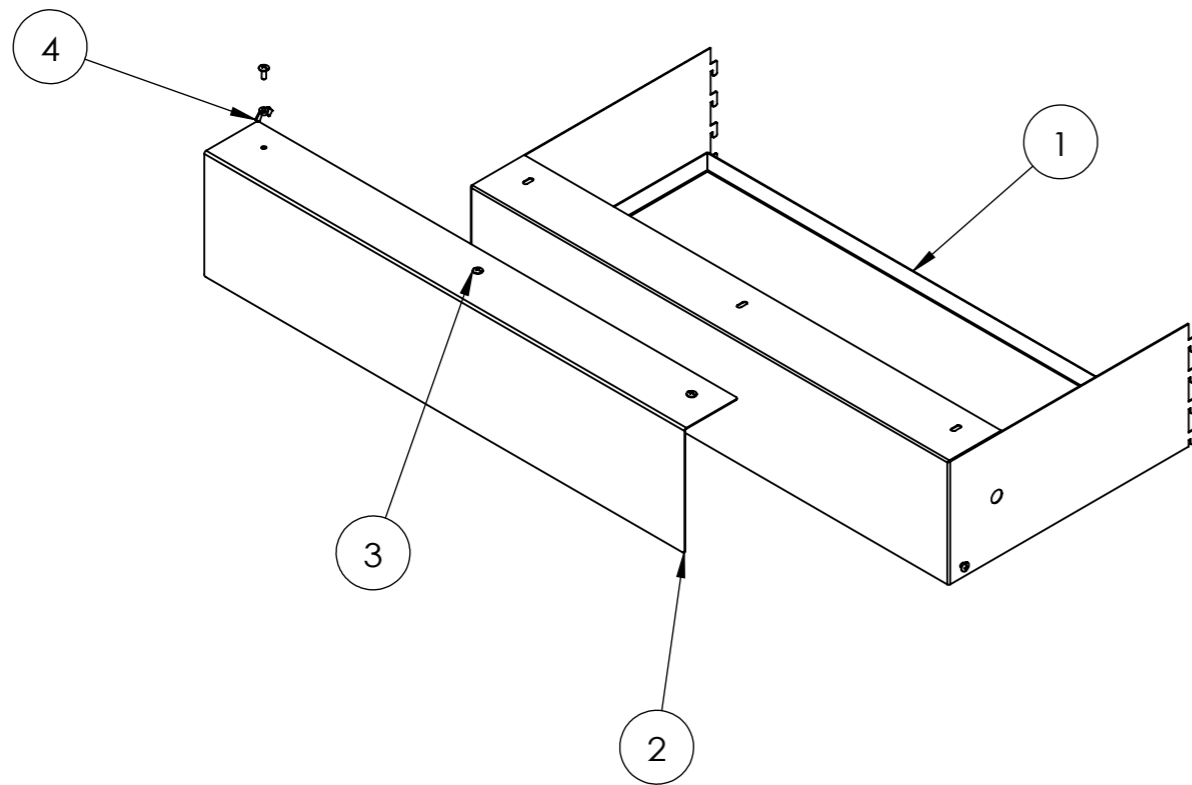

T 03 8787 3000 F 03 8787 3025
48-58 Cyber Loop, Dandenong South
VIC 3175 (AUSTRALIA)

© COPYRIGHT. This drawing is the exclusive property of Associated Projects Pty Ltd. It is subject to protection and is strictly confidential. Reproduction in whole or in part is prohibited without obtaining prior permission in writing from the proprietor.

Rev	Date	Description

ALL DIMENSIONS IN (mm)
UNLESS OTHERWISE SPECIFIED
BREAK ALL SHARP EDGES

TOLERANCES
(BEFORE PAINTING
& AFTER PLATING)
X ± 1.00
X.X ± 0.50
X.XX ± 0.10
ANGLES ± 0.5°

A05- EXPLODED VIEW

CLIENT: RFA

PROJ. NO.: TBA

FINISH: CUSTOMISED

MAT'L: MILD STEEL

Page 5

PELMET COVER - W900XH200 - CUSTOM COLOUR
(TO SUIT CLIENT)

PRODUCT CODE: **RFA2148**

Date: 1/11/2023

Drawn by PS

Checked by NP

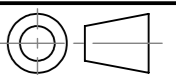

DO NOT SCALE

Scale@A3 1:10