



T 03 8787 3000 F 03 8787 3025  
 48-58 Cyber Loop, Dandenong South  
 VIC 3175 (AUSTRALIA)

© COPYRIGHT. This drawing is the exclusive property of Associated Projects Pty Ltd. It is subject to protection and is strictly confidential. Reproduction in whole or in part is prohibited without obtaining prior permission in writing from the proprietor.

Rev	Date	Description

ALL DIMENSIONS IN (mm)  
 UNLESS OTHERWISE SPECIFIED  
 BREAK ALL SHARP EDGES

TOLERANCES  
 (BEFORE PAINTING  
 & AFTER PLATING)  
 X ± 1.00  
 X.X ± 0.50  
 X.XX ± 0.10  
 ANGLES ± 0.5°

A01- RENDER  
 CLIENT: -  
 PROJ. NO.: TBA  
 FINISH: P/C MATTE BLACK  
 MAT'L: VARIOUS  
 Page 1

DENSE END - SOFT SHELL TRIPLE END SET - H1515  
 -

PRODUCT CODE: **RFA2096**

Date: 12/07/2024

Drawn by DH

Checked by NP

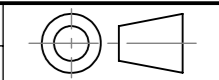

DO NOT SCALE

Scale@A3 1:1



RENDER WITH GONDOLA END W/ INTERLOCKER



T 03 8787 3000 F 03 8787 3025  
 48-58 Cyber Loop, Dandenong South  
 VIC 3175 (AUSTRALIA)

© COPYRIGHT. This drawing is the exclusive property of Associated Projects Pty Ltd. It is subject to protection and is strictly confidential. Reproduction in whole or in part is prohibited without obtaining prior permission in writing from the proprietor.

Rev	Date	Description

ALL DIMENSIONS IN (mm)  
 UNLESS OTHERWISE SPECIFIED  
 BREAK ALL SHARP EDGES

TOLERANCES  
 (BEFORE PAINTING  
 & AFTER PLATING)  
 X ± 1.00  
 X.X ± 0.50  
 X.XX ± 0.10  
 ANGLES ± 0.5°

A02- RENDER  
 CLIENT: -  
 PROJ. NO.: TBA  
 FINISH: P/C MATTE BLACK  
 MAT'L: VARIOUS  
 Page 2

DENSE END - SOFT SHELL TRIPLE END SET - H1515		
-		
PRODUCT CODE: <b>RFA2096</b>		
Date:	12/07/2024	
Drawn by	DH	
Checked by	NP	
Scale@A3		1:1

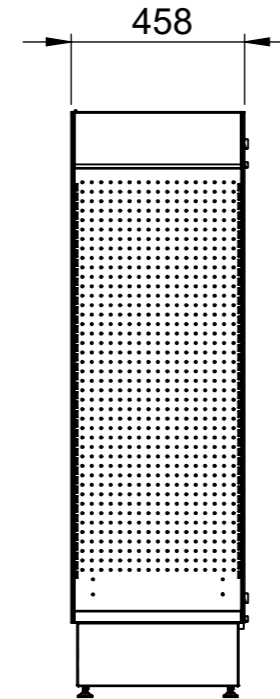
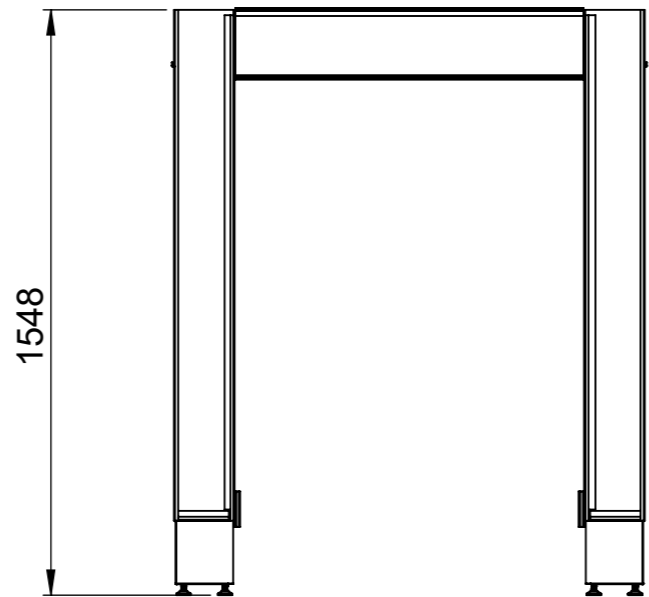
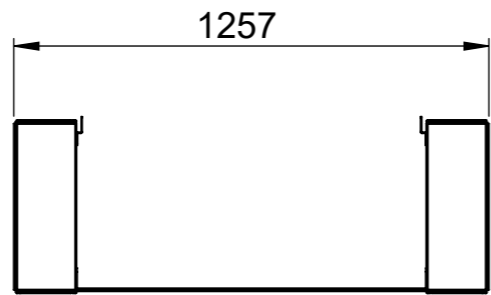
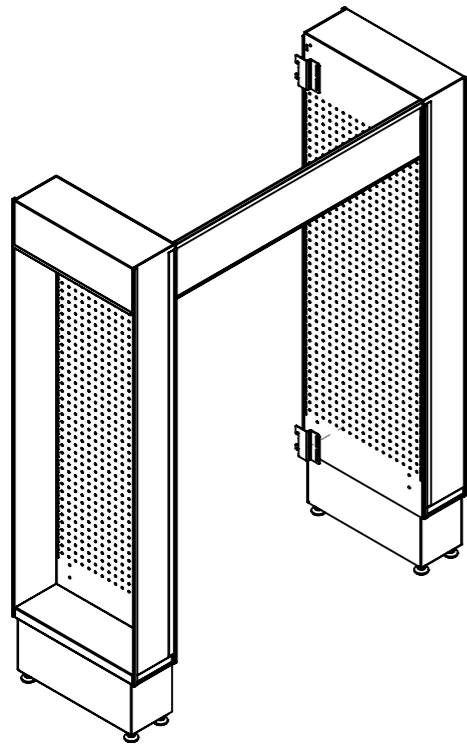

T 03 8787 3000 F 03 8787 3025  
48-58 Cyber Loop, Dandenong South  
VIC 3175 (AUSTRALIA)

© COPYRIGHT. This drawing is the exclusive property of Associated Projects Pty Ltd. It is subject to protection and is strictly confidential. Reproduction in whole or in part is prohibited without obtaining prior permission in writing from the proprietor.

Rev	Date	Description

ALL DIMENSIONS IN (mm)  
UNLESS OTHERWISE SPECIFIED  
BREAK ALL SHARP EDGES

TOLERANCES  
(BEFORE PAINTING  
& AFTER PLATING)  
X ± 1.00  
X.X ± 0.50  
X.XX ± 0.10  
ANGLES ± 0.5°

A03- CLIENT  
CLIENT: -  
PROJ. NO.: TBA  
FINISH: P/C MATTE BLACK  
MAT'L: VARIOUS  
Page 3

DENSE END - SOFT SHELL TRIPLE END SET - H1515		
-		
PRODUCT CODE: <b>RFA2096</b>	Date: 12/07/2024	
Drawn by DH	Checked by NP	
Scale@A3 1:20		

ITEM NO.	PRODUCT CODE	DESCRIPTION	FINISH	QTY.
1	RFA2347	DENSE END - UNIT - H1815	P/C MATTE BLACK	2
2	-	DENSE END - JOINER BRACKET (2 X PER DENSE END)	P/C MATTE BLACK	2
3	RFA2349	DENSE END - FACE PLATE - W630XH100	P/C MATTE BLACK	1

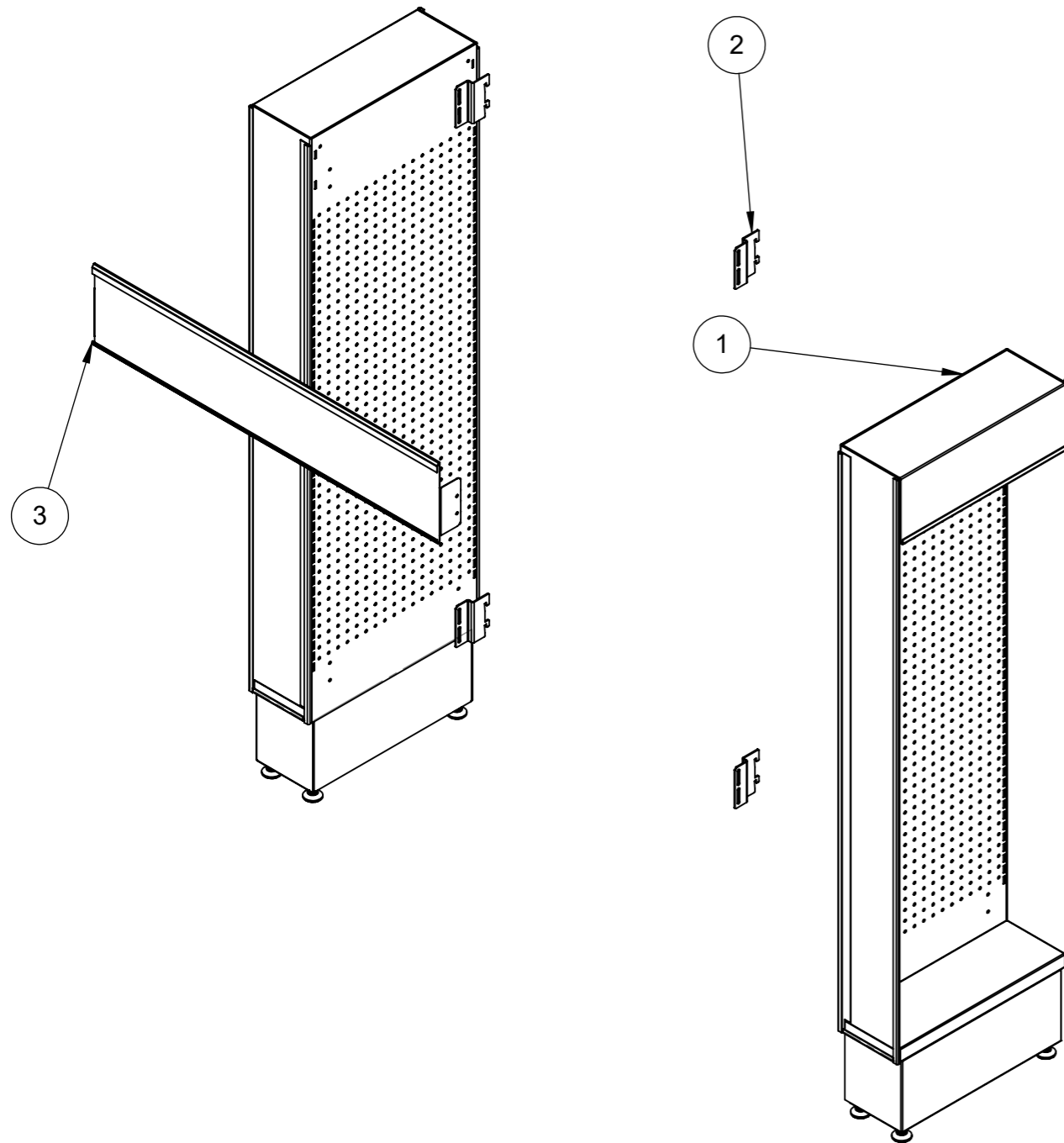

T 03 8787 3000 F 03 8787 3025  
48-58 Cyber Loop, Dandenong South  
VIC 3175 (AUSTRALIA)

© COPYRIGHT. This drawing is the exclusive property of Associated Projects Pty Ltd. It is subject to protection and is strictly confidential. Reproduction in whole or in part is prohibited without obtaining prior permission in writing from the proprietor.

Rev	Date	Description

ALL DIMENSIONS IN (mm)  
UNLESS OTHERWISE SPECIFIED  
BREAK ALL SHARP EDGES

TOLERANCES  
(BEFORE PAINTING  
& AFTER PLATING)  
X ± 1.00  
X.X ± 0.50  
X.XX ± 0.10  
ANGLES ± 0.5°

A04- EXPLODED VIEW

CLIENT: -

PROJ. NO.: TBA

FINISH: P/C MATTE BLACK

MAT'L: VARIOUS

Page 4

DENSE END - SOFT SHELL TRIPLE END SET - H1515

-

PRODUCT CODE: **RFA2096**

Date: 12/07/2024

Drawn by DH

Checked by NP

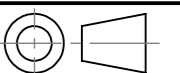

DO NOT SCALE

Scale@A3 1:20