



This product is an Add Bay  
 \* Supplied with (1) post only  
 \* Connects to the post of the neighboring Bay



T 03 8787 3000 F 03 8787 3025  
 48-58 Cyber Loop, Dandenong South  
 VIC 3175 (AUSTRALIA)

© COPYRIGHT. This drawing is the exclusive property of Associated Projects Pty Ltd. It is subject to protection and is strictly confidential. Reproduction in whole or in part is prohibited without obtaining prior permission in writing from the proprietor.

Rev	Date	Description

ALL DIMENSIONS IN (mm)  
 UNLESS OTHERWISE SPECIFIED  
 BREAK ALL SHARP EDGES

TOLERANCES  
 (BEFORE PAINTING  
 & AFTER PLATING)  
 X ± 1.00  
 X.X ± 0.50  
 X.XX ± 0.10  
 ANGLES ± 0.5°

A01- RENDER  
 CLIENT: -  
 PROJ. NO.: TBA  
 FINISH: P/C MATTE BLACK  
 MAT'L: VARIOUS  
 Page 1

ADD BAY - DOUBLE SIDED GONDOLA - CLIP IN -  
 GRAPHIC PANEL - W600XH1815XD450

PRODUCT CODE: **RFA2083**

Date: 26/10/2023

Drawn by DH

Checked by NP

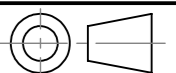

DO NOT SCALE

Scale@A3 1:15



RENDER WITH ARTWORK INSERTED



T 03 8787 3000 F 03 8787 3025  
48-58 Cyber Loop, Dandenong South  
VIC 3175 (AUSTRALIA)

© COPYRIGHT. This drawing is the exclusive property of Associated Projects Pty Ltd. It is subject to protection and is strictly confidential. Reproduction in whole or in part is prohibited without obtaining prior permission in writing from the proprietor.

Rev	Date	Description

ALL DIMENSIONS IN (mm)  
UNLESS OTHERWISE SPECIFIED  
BREAK ALL SHARP EDGES

TOLERANCES  
(BEFORE PAINTING  
& AFTER PLATING)  
X ± 1.00  
X.X ± 0.50  
X.XX ± 0.10  
ANGLES ± 0.5°

**A02- RENDER**  
**CLIENT: -**  
**PROJ. NO.: TBA**  
**FINISH: P/C MATTE BLACK**  
**MAT'L: VARIOUS**  
**Page 2**

**ADD BAY - DOUBLE SIDED GONDOLA - CLIP IN GRAPHIC PANEL - W600XH1815XD450**

<b>PRODUCT CODE: RFA2083</b>		
Date:	26/10/2023	
Drawn by	DH	DO NOT SCALE
Checked by	NP	Scale@A3 1:15

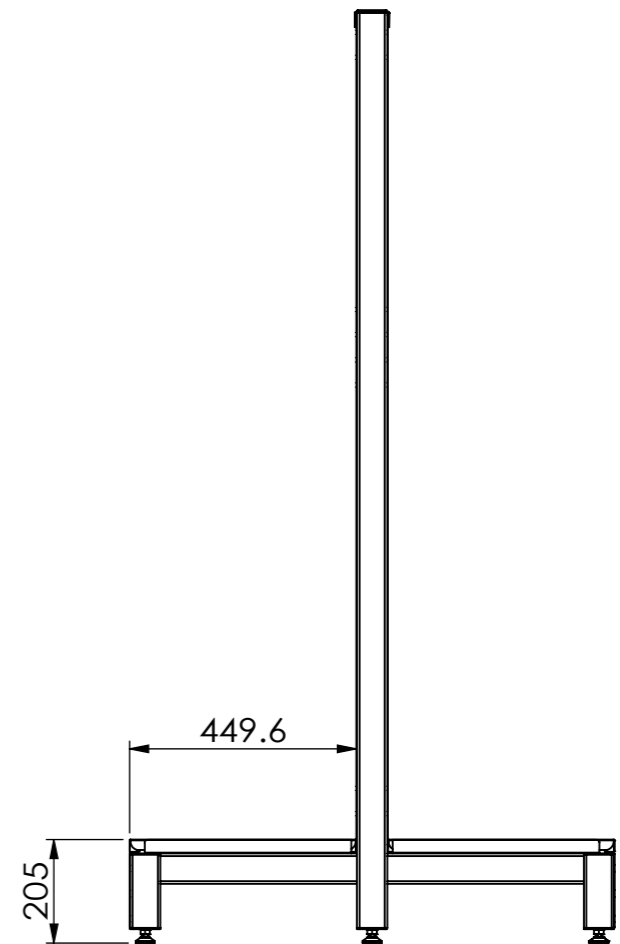
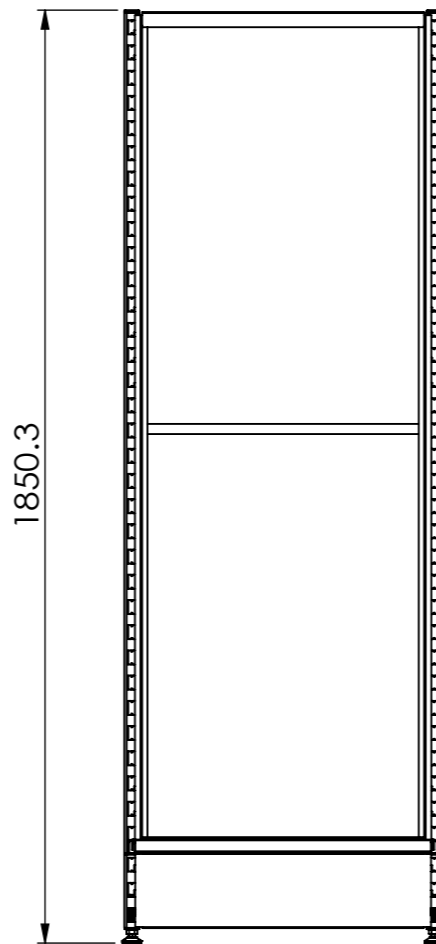
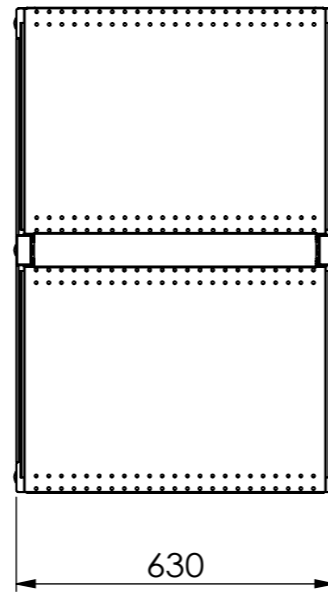
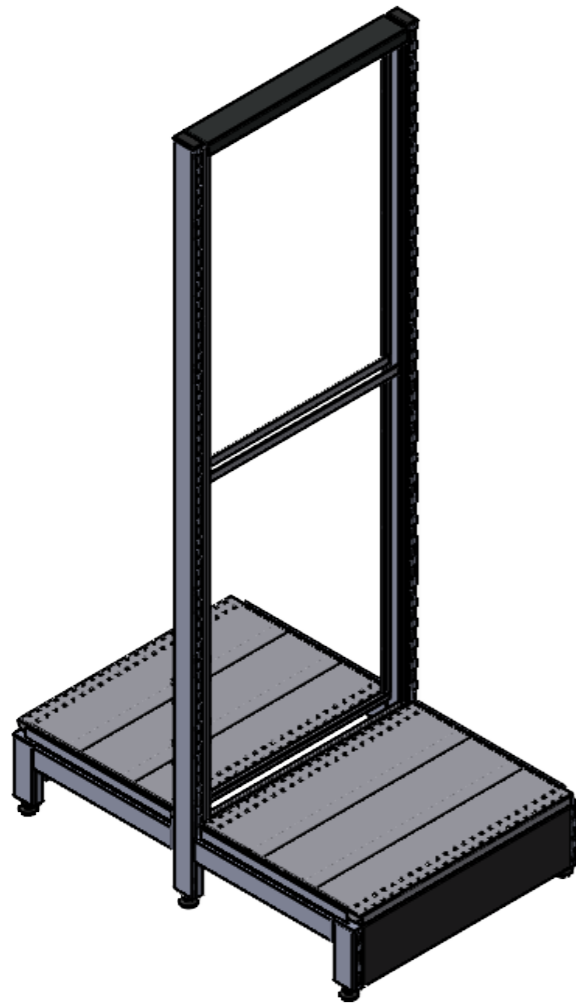

T 03 8787 3000 F 03 8787 3025  
 48-58 Cyber Loop, Dandenong South  
 VIC 3175 (AUSTRALIA)

© COPYRIGHT. This drawing is the exclusive property of Associated Projects Pty Ltd. It is subject to protection and is strictly confidential. Reproduction in whole or in part is prohibited without obtaining prior permission in writing from the proprietor.

Rev	Date	Description

ALL DIMENSIONS IN (mm)  
 UNLESS OTHERWISE SPECIFIED  
 BREAK ALL SHARP EDGES

TOLERANCES  
 (BEFORE PAINTING  
 & AFTER PLATING)  
 X ± 1.00  
 X.X ± 0.50  
 X.XX ± 0.10  
 ANGLES ± 0.5°

A03- CLIENT

CLIENT: -

PROJ. NO.: TBA

FINISH: P/C MATTE BLACK

MAT'L: VARIOUS

Page 3

ADD BAY - DOUBLE SIDED GONDOLA - CLIP IN  
 GRAPHIC PANEL - W600XH1815XD450

PRODUCT CODE: **RFA2083**

Date: 26/10/2023

Drawn by DH

Checked by NP

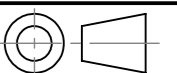

DO NOT SCALE

Scale@A3 1:15

ITEM NO.	PRODUCT CODE	DESCRIPTION	FINISH	QTY.
1	RFA2332	POST - GONDOLA - DOUBLE SIDED - H1815XD900 - W/.D 450 LEGS	P/C MATTE BLACK	2
2	RFA2363	CLIP IN GRAPHIC FRAME - W600XH1680 - FOR CLIP IN GRAPHIC PANEL	P/C MATTE BLACK	2
3	RFA2321	600W X 150H SKIRT	P/C MATTE BLACK	2
4	RFA0408	SHELF - W600XD450 - W/. DOUBLE STIFFENER	P/C MATTE BLACK	2
5	RFA2333	TOP CAP - W600XH30 - W/. H30 RETURN FOLDS	P/C MATTE BLACK	1
6	-	ADJ. FEET OD38_M12_H70THD	RAW	6
7	-	PLASTIC ENDCAP	BLACK	2

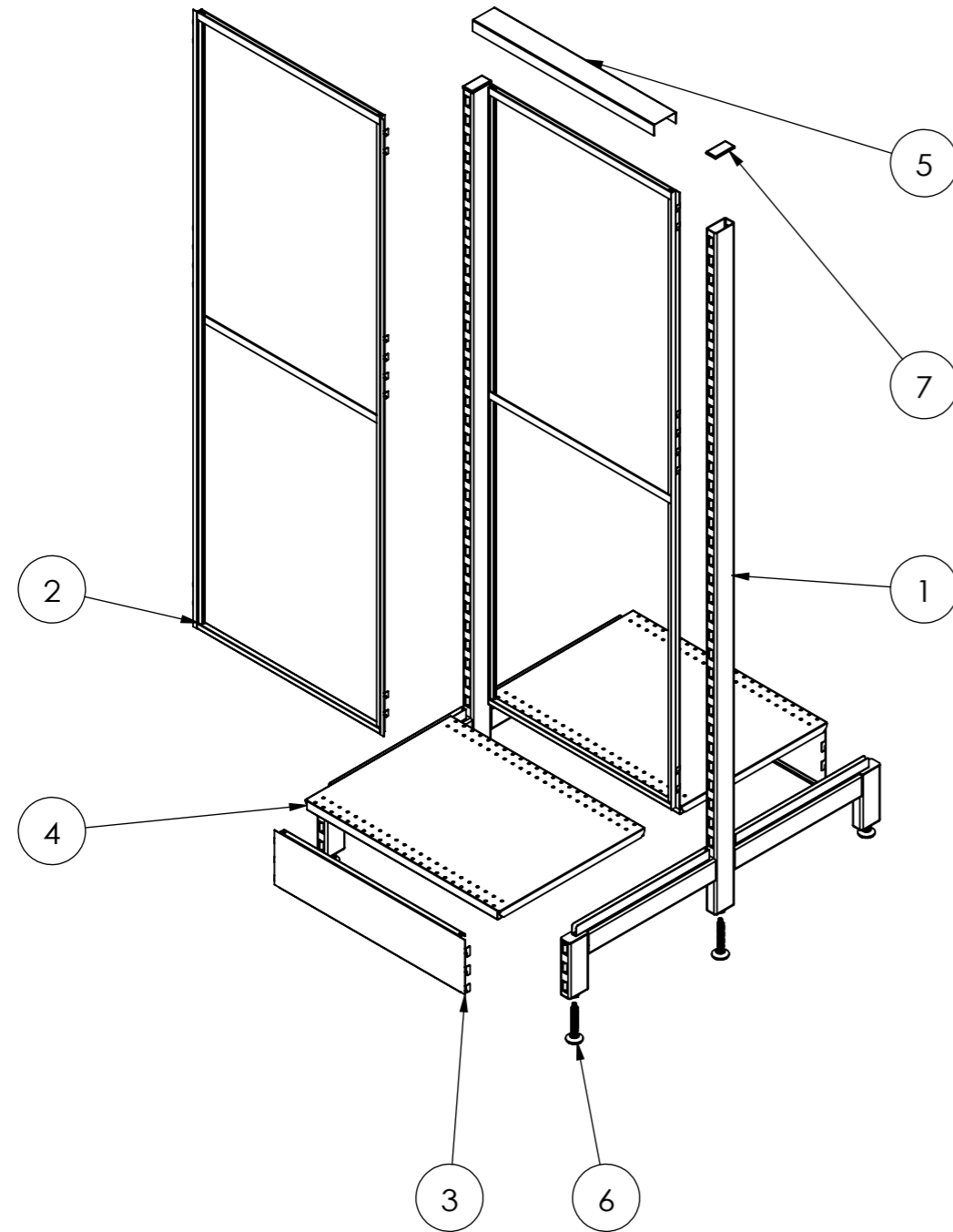

T 03 8787 3000 F 03 8787 3025  
48-58 Cyber Loop, Dandenong South  
VIC 3175 (AUSTRALIA)

© COPYRIGHT. This drawing is the exclusive property of Associated Projects Pty Ltd. It is subject to protection and is strictly confidential. Reproduction in whole or in part is prohibited without obtaining prior permission in writing from the proprietor.

Rev	Date	Description

ALL DIMENSIONS IN (mm)  
UNLESS OTHERWISE SPECIFIED  
BREAK ALL SHARP EDGES

TOLERANCES  
(BEFORE PAINTING  
& AFTER PLATING)  
X ± 1.00  
X.X ± 0.50  
X.XX ± 0.10  
ANGLES ± 0.5°

A04- EXPLODED VIEW

CLIENT: -

PROJ. NO.: TBA

FINISH: P/C MATTE BLACK

MAT'L: VARIOUS

Page 4

ADD BAY - DOUBLE SIDED GONDOLA - CLIP IN GRAPHIC PANEL - W600XH1815XD450

PRODUCT CODE: **RFA2083**

Date: 26/10/2023

Drawn by DH

Checked by NP

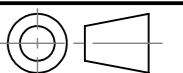

DO NOT SCALE

Scale@A3 1:15