

T 03 8787 3000 F 03 8787 3025
 48-58 Cyber Loop, Dandenong South
 VIC 3175 (AUSTRALIA)

© COPYRIGHT. This drawing is the exclusive property of Associated Projects Pty Ltd. It is subject to protection and is strictly confidential. Reproduction in whole or in part is prohibited without obtaining prior permission in writing from the proprietor.

Rev	Date	Description

ALL DIMENSIONS IN (mm)
 UNLESS OTHERWISE SPECIFIED
 BREAK ALL SHARP EDGES

TOLERANCES
 (BEFORE PAINTING
 & AFTER PLATING)
 X ± 1.00
 X.X ± 0.50
 X.XX ± 0.10
 ANGLES ± 0.5°

A01- RENDER
CLIENT: -
PROJ. NO.: TBA
FINISH: P/C MATTE BLACK
MAT'L: Material <not specified>
Page 1

START BAY - DOUBLE SIDED GONDOLA - SOFT SHELL - W600XH1815XD450 - NON PERFORATED

PRODUCT CODE: RFA2064

Date: 11/10/2023

Drawn by DH

Checked by NP

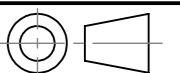

DO NOT SCALE

Scale@A3 1:20

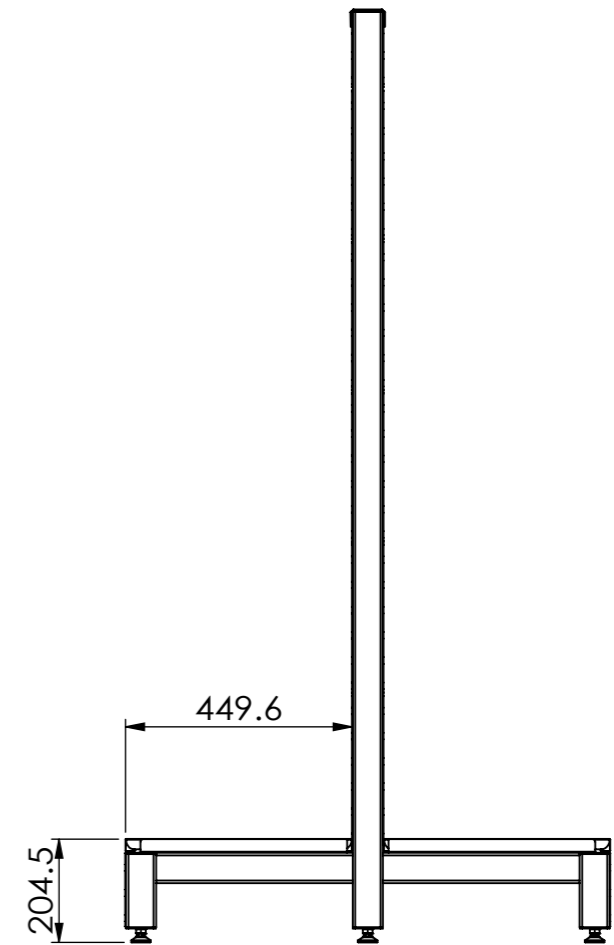
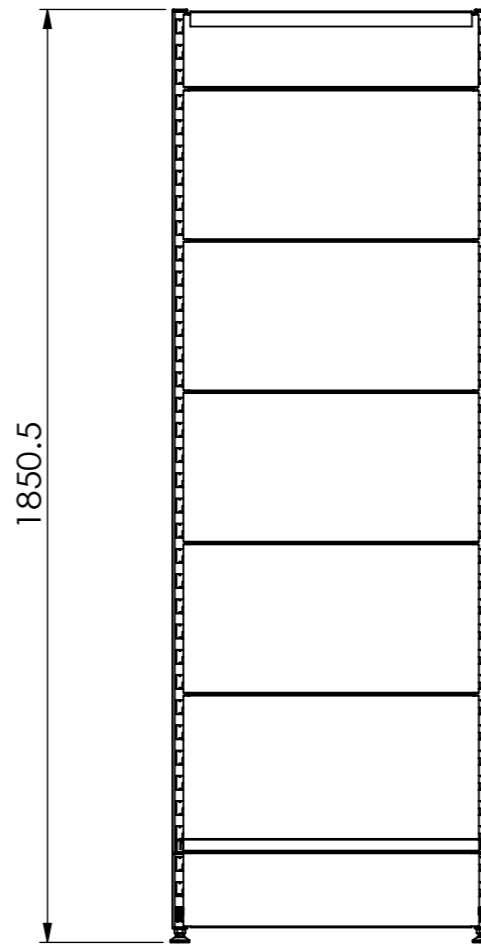
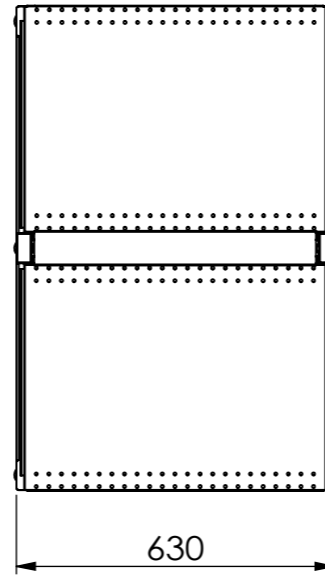
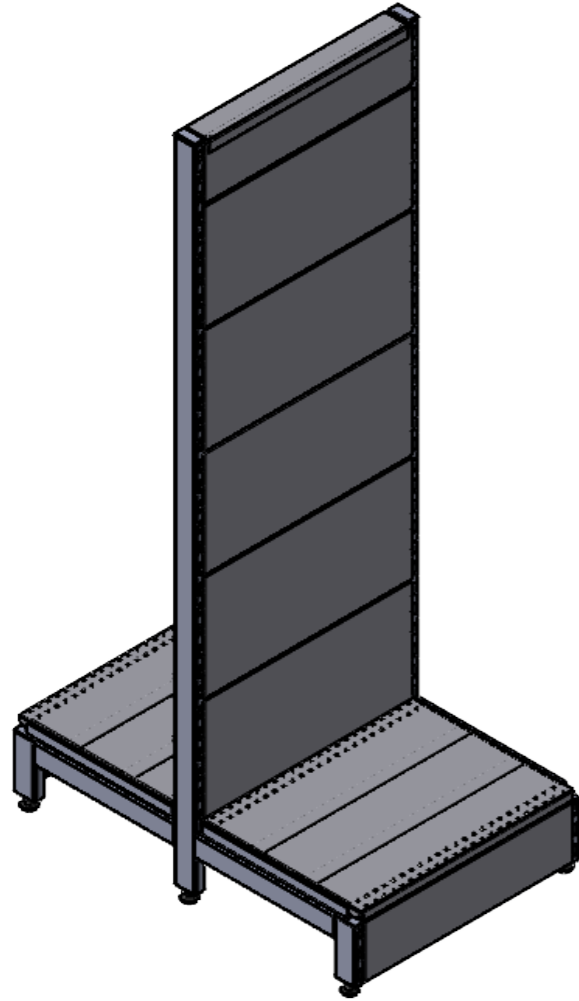

T 03 8787 3000 F 03 8787 3025
48-58 Cyber Loop, Dandenong South
VIC 3175 (AUSTRALIA)

© COPYRIGHT. This drawing is the exclusive property of Associated Projects Pty Ltd. It is subject to protection and is strictly confidential. Reproduction in whole or in part is prohibited without obtaining prior permission in writing from the proprietor.

Rev	Date	Description

ALL DIMENSIONS IN (mm)
UNLESS OTHERWISE SPECIFIED
BREAK ALL SHARP EDGES

TOLERANCES
(BEFORE PAINTING
& AFTER PLATING)
X ± 1.00
X.X ± 0.50
X.XX ± 0.10
ANGLES ± 0.5°

A02- CLIENT

CLIENT: -

PROJ. NO.: TBA

FINISH: P/C MATTE BLACK

MAT'L: Material <not specified>

Page 2

START BAY - DOUBLE SIDED GONDOLA - SOFT
SHELL - W600XH1815XD450 - NON PERFORATED

PRODUCT CODE: **RFA2064**

Date: 11/10/2023

Drawn by DH

Checked by NP

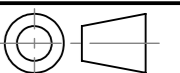

DO NOT SCALE

Scale@A3 1:15

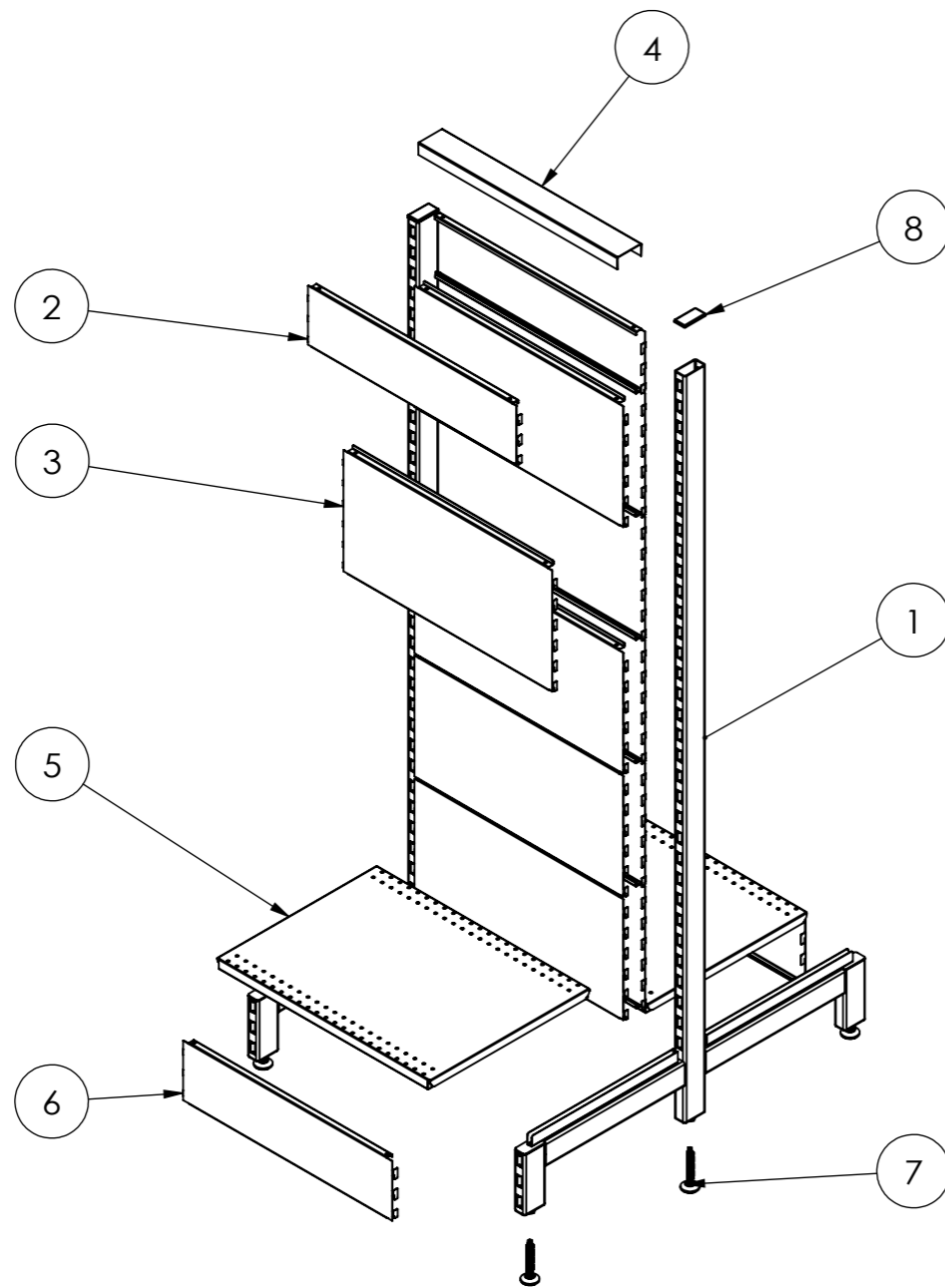

ITEM NO.	PRODUCT CODE	DESCRIPTION	FINISH	QTY.
1	RFA2332	POST - GONDOLA - DOUBLE SIDED - H1815XD900 - W/.D 450 LEGS	P/C MATTE BLACK	2
2	RFA2309	CLIP IN PANEL - W600XH150 - NON PERFORATED	P/C MATTE BLACK	2
3	RFAF2313	CLIP IN PANEL - W600XH300 - NON PERFORATED	P/C MATTE BLACK	10
4	RFA2333	TOP CAP - W600XH30 - W/. H30 RETURN FOLDS	P/C MATTE BLACK	1
5	RFA0408	SHELF - W600XD450 - W/. DOUBLE STIFFENER	P/C MATTE BLACK	2
6	RFA2321	600W X 150H SKIRT	P/C MATTE BLACK	2
7	-	ADJ. FEET OD38_M12_H70THD	RAW	6
8	-	PLASTIC ENDCAP	BLACK	2



T 03 8787 3000 F 03 8787 3025
48-58 Cyber Loop, Dandenong South
VIC 3175 (AUSTRALIA)

© COPYRIGHT. This drawing is the exclusive property of Associated Projects Pty Ltd. It is subject to protection and is strictly confidential. Reproduction in whole or in part is prohibited without obtaining prior permission in writing from the proprietor.

Rev	Date	Description

ALL DIMENSIONS IN (mm)
UNLESS OTHERWISE SPECIFIED
BREAK ALL SHARP EDGES

TOLERANCES
(BEFORE PAINTING
& AFTER PLATING)
X ± 1.00
X.X ± 0.50
X.XX ± 0.10
ANGLES ± 0.5°

A03- EXPLODED VIEW
CLIENT: -
PROJ. NO.: TBA
FINISH: P/C MATTE BLACK
MAT'L: Material <not specified>
Page 3

START BAY - DOUBLE SIDED GONDOLA - SOFT SHELL - W600XH1815XD450 - NON PERFORATED

PRODUCT CODE: **RFA2064**

Date: 11/10/2023

Drawn by DH

Checked by NP

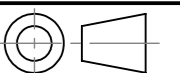

DO NOT SCALE

Scale@A3 1:15