



T 03 8787 3000 F 03 8787 3025
 48-58 Cyber Loop, Dandenong South
 VIC 3175 (AUSTRALIA)

© COPYRIGHT. This drawing is the exclusive property of Associated Projects Pty Ltd. It is subject to protection and is strictly confidential. Reproduction in whole or in part is prohibited without obtaining prior permission in writing from the proprietor.

Rev	Date	Description

ALL DIMENSIONS IN (mm)
 UNLESS OTHERWISE SPECIFIED
 BREAK ALL SHARP EDGES

TOLERANCES
 (BEFORE PAINTING
 & AFTER PLATING)
 X ± 1.00
 X.X ± 0.50
 X.XX ± 0.10
 ANGLES ± 0.5°

A01- RENDER
 CLIENT: -
 PROJ. NO.: TBA
 FINISH: P/C MATTE BLACK
 MAT'L: VARIOUS
 Page 1

START BAY - DOUBLE SIDED GONDOLA - CLIP IN
 GRAPHIC PANEL - W900XH1515XD450

PRODUCT CODE: **RFA2056**

Date: 26/10/2023

Drawn by DH

Checked by NP

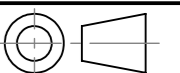

DO NOT SCALE

Scale@A3 1:15

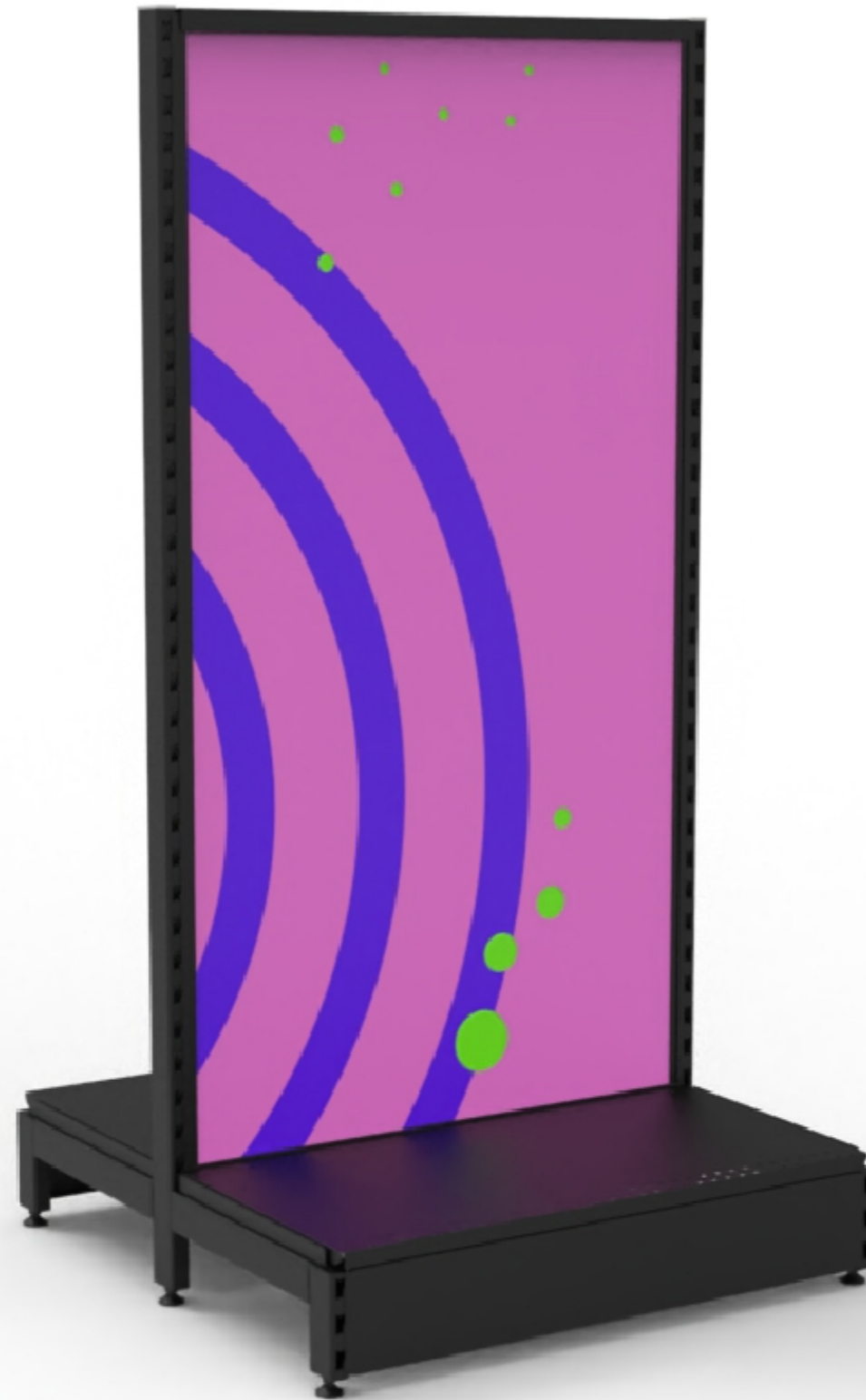

RENDER WITH ARTWORK INSERTED



T 03 8787 3000 F 03 8787 3025
48-58 Cyber Loop, Dandenong South
VIC 3175 (AUSTRALIA)

© COPYRIGHT. This drawing is the exclusive property of Associated Projects Pty Ltd. It is subject to protection and is strictly confidential. Reproduction in whole or in part is prohibited without obtaining prior permission in writing from the proprietor.

Rev	Date	Description

ALL DIMENSIONS IN (mm)
UNLESS OTHERWISE SPECIFIED
BREAK ALL SHARP EDGES

TOLERANCES
(BEFORE PAINTING
& AFTER PLATING)
X ± 1.00
X.X ± 0.50
X.XX ± 0.10
ANGLES ± 0.5°

A02- RENDER

CLIENT: -

PROJ. NO.: TBA

FINISH: P/C MATTE BLACK

MAT'L: VARIOUS

Page 2

START BAY - DOUBLE SIDED GONDOLA - CLIP IN
GRAPHIC PANEL - W900XH1515XD450

PRODUCT CODE: **RFA2056**

Date: 26/10/2023

Drawn by DH

Checked by NP

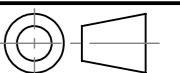

DO NOT SCALE

Scale@A3 1:15

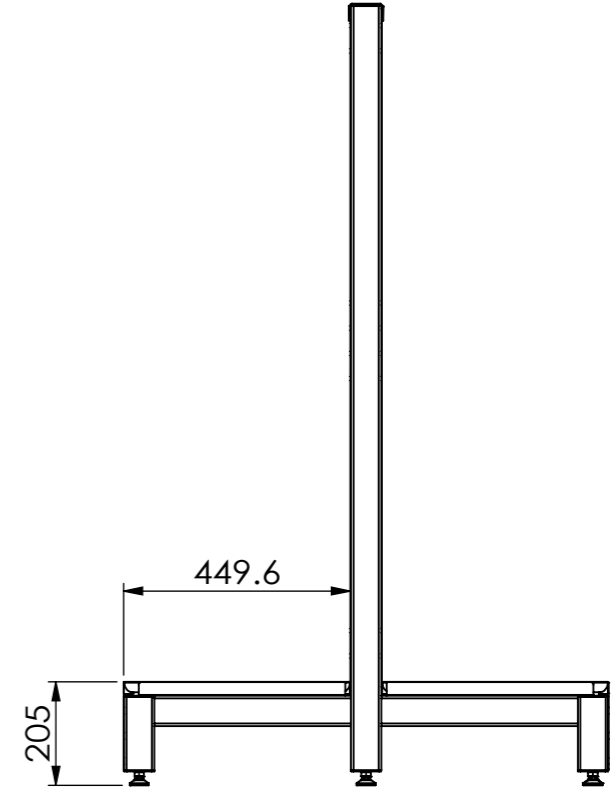
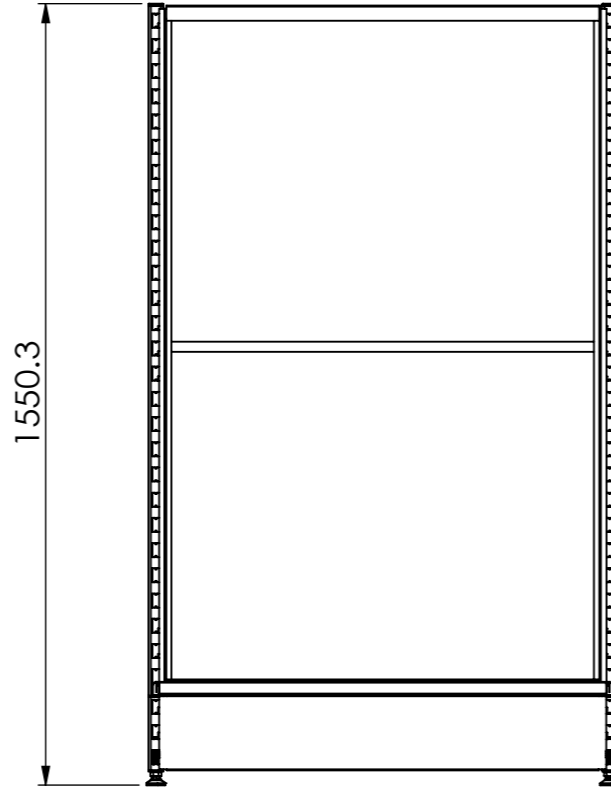
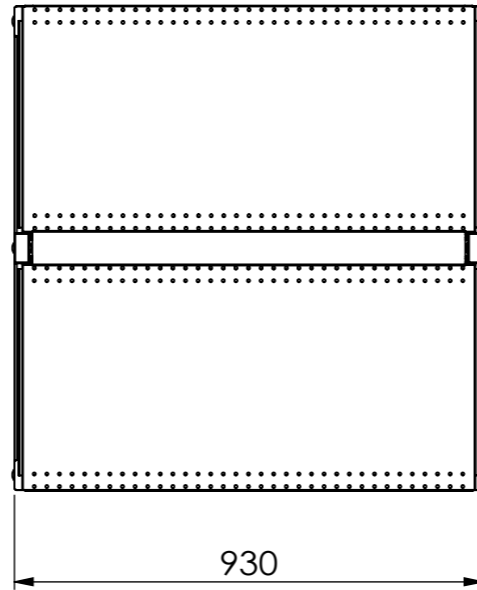

T 03 8787 3000 F 03 8787 3025
 48-58 Cyber Loop, Dandenong South
 VIC 3175 (AUSTRALIA)

© COPYRIGHT. This drawing is the exclusive property of Associated Projects Pty Ltd. It is subject to protection and is strictly confidential. Reproduction in whole or in part is prohibited without obtaining prior permission in writing from the proprietor.

Rev	Date	Description

ALL DIMENSIONS IN (mm)
 UNLESS OTHERWISE SPECIFIED
 BREAK ALL SHARP EDGES

TOLERANCES
 (BEFORE PAINTING
 & AFTER PLATING)
 X ± 1.00
 X.X ± 0.50
 X.XX ± 0.10
 ANGLES ± 0.5°

A03- CLIENT
 CLIENT: -
 PROJ. NO.: TBA
 FINISH: P/C MATTE BLACK
 MAT'L: VARIOUS
 Page 3

START BAY - DOUBLE SIDED GONDOLA - CLIP IN GRAPHIC PANEL - W900XH1515XD450		
PRODUCT CODE: RFA2056	Date: 26/10/2023	
Drawn by: DH	Checked by: NP	DO NOT SCALE
Scale@A3 1:15		

ITEM NO.	PRODUCT CODE	DESCRIPTION	FINISH	QTY.
1	RFA2331	POST - GONDOLA - DOUBLE SIDED - H1515XD900	P/C MATTE BLACK	2
2	RFA2362	CLIP IN GRAPHIC FRAME - W900XH1380 - FOR CLIP IN GRAPHIC PANEL	P/C MATTE BLACK	2
3	RFA2322	900W X 150H SKIRT	P/C MATTE BLACK	2
4	RFA0411	SHELF - W900XD450 - W/. DOUBLE STIFFENER	P/C MATTE BLACK	2
5	RFA2334	TOP CAP - W900XH30 - W/. H30 RETURN FOLDS	P/C MATTE BLACK	1
6	-	PLASTIC ENDCAP	BLACK	2
7	-	ADJ. FEET OD38_M12_H70THD	RAW	6

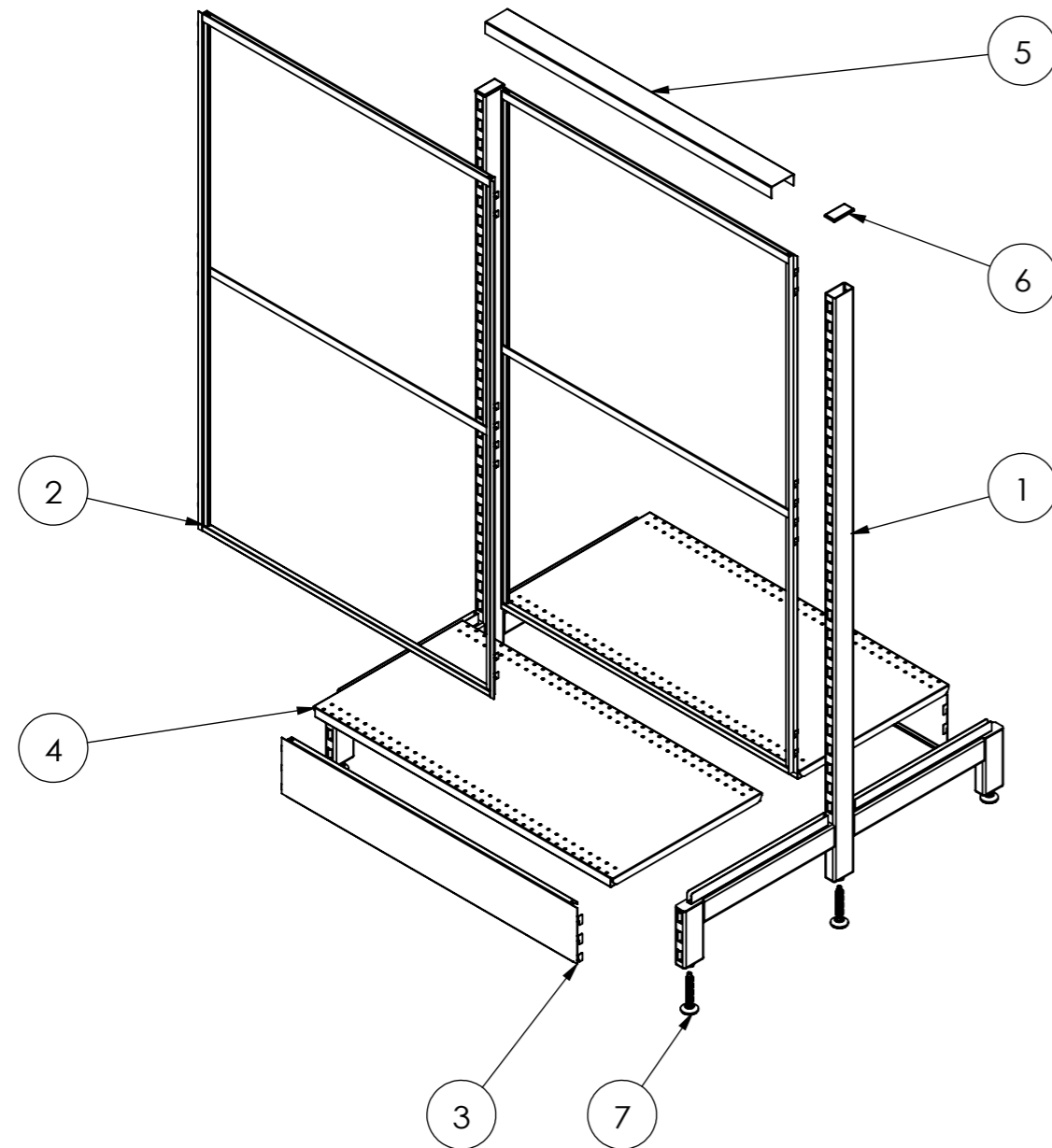

T 03 8787 3000 F 03 8787 3025
48-58 Cyber Loop, Dandenong South
VIC 3175 (AUSTRALIA)

© COPYRIGHT. This drawing is the exclusive property of Associated Projects Pty Ltd. It is subject to protection and is strictly confidential. Reproduction in whole or in part is prohibited without obtaining prior permission in writing from the proprietor.

Rev	Date	Description

ALL DIMENSIONS IN (mm)
UNLESS OTHERWISE SPECIFIED
BREAK ALL SHARP EDGES

TOLERANCES
(BEFORE PAINTING
& AFTER PLATING)
X ± 1.00
X.X ± 0.50
X.XX ± 0.10
ANGLES ± 0.5°

A04- EXPLODED VIEW

CLIENT: -

PROJ. NO.: TBA

FINISH: P/C MATTE BLACK

MAT'L: VARIOUS

Page 4

START BAY - DOUBLE SIDED GONDOLA - CLIP IN GRAPHIC PANEL - W900XH1515XD450

PRODUCT CODE: **RFA2056**

Date: 26/10/2023

Drawn by DH

Checked by NP

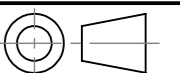

DO NOT SCALE

Scale@A3 1:15