



T 03 8787 3000 F 03 8787 3025  
 48-58 Cyber Loop, Dandenong South  
 VIC 3175 (AUSTRALIA)

© COPYRIGHT. This drawing is the exclusive property of Associated Projects Pty Ltd. It is subject to protection and is strictly confidential. Reproduction in whole or in part is prohibited without obtaining prior permission in writing from the proprietor.

Rev	Date	Description

ALL DIMENSIONS IN (mm)  
 UNLESS OTHERWISE SPECIFIED  
 BREAK ALL SHARP EDGES

TOLERANCES  
 (BEFORE PAINTING  
 & AFTER PLATING)  
 X ± 1.00  
 X.X ± 0.50  
 X.XX ± 0.10  
 ANGLES ± 0.5°

A01- RENDER  
 CLIENT: -  
 PROJ. NO.: TBA  
 FINISH: P/C MATTE BLACK  
 MAT'L: Material <not specified>  
 Page 1

START BAY - DOUBLE SIDED GONDOLA - SOFT  
 SHELL - W900XH1515XD450 - SLAT WALL

PRODUCT CODE: **RFA2044**

Date: 11/10/2023

Drawn by DH

Checked by NP

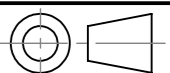

DO NOT SCALE

Scale@A3 1:20

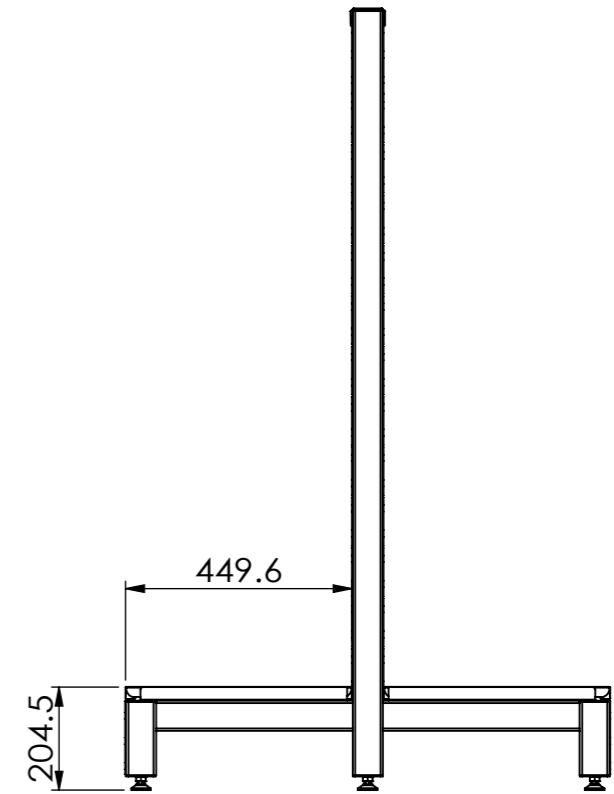
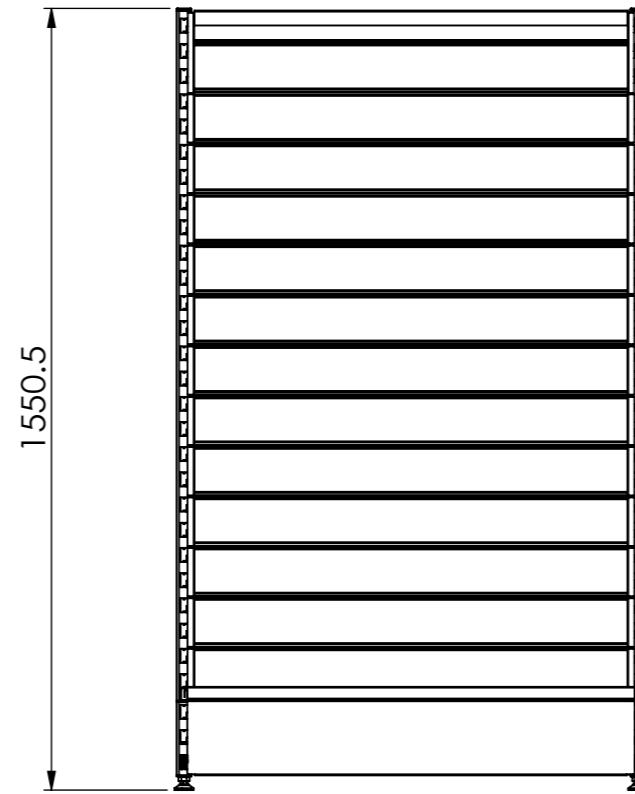
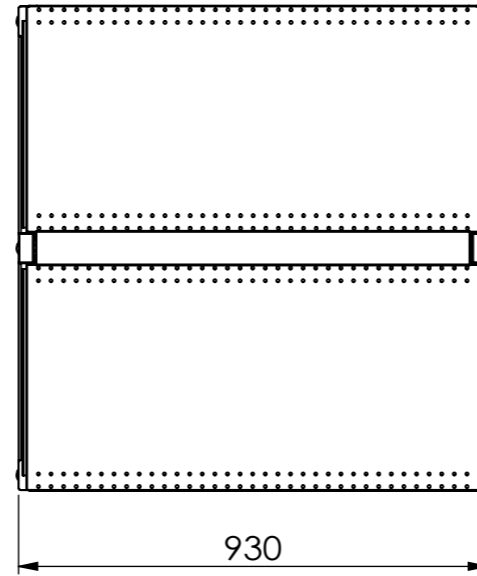
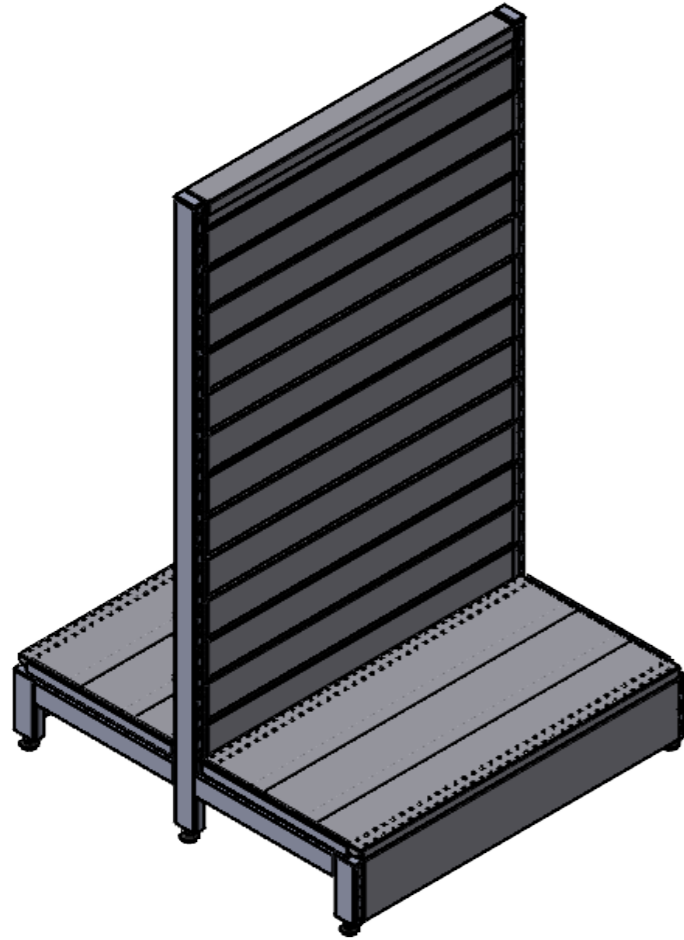

T 03 8787 3000 F 03 8787 3025  
 48-58 Cyber Loop, Dandenong South  
 VIC 3175 (AUSTRALIA)

© COPYRIGHT. This drawing is the exclusive property of Associated Projects Pty Ltd. It is subject to protection and is strictly confidential. Reproduction in whole or in part is prohibited without obtaining prior permission in writing from the proprietor.

Rev	Date	Description

ALL DIMENSIONS IN (mm)  
 UNLESS OTHERWISE SPECIFIED  
 BREAK ALL SHARP EDGES

TOLERANCES  
 (BEFORE PAINTING  
 & AFTER PLATING)  
 X ± 1.00  
 X.X ± 0.50  
 X.XX ± 0.10  
 ANGLES ± 0.5°

A02- CLIENT

CLIENT: -

PROJ. NO.: TBA

FINISH: P/C MATTE BLACK

MAT'L: Material <not specified>

Page 2

START BAY - DOUBLE SIDED GONDOLA - SOFT  
 SHELL - W900XH1515XD450 - SLAT WALL

PRODUCT CODE: **RFA2044**

Date: 11/10/2023

Drawn by DH

Checked by NP

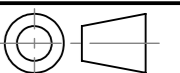

DO NOT SCALE

Scale@A3 1:15

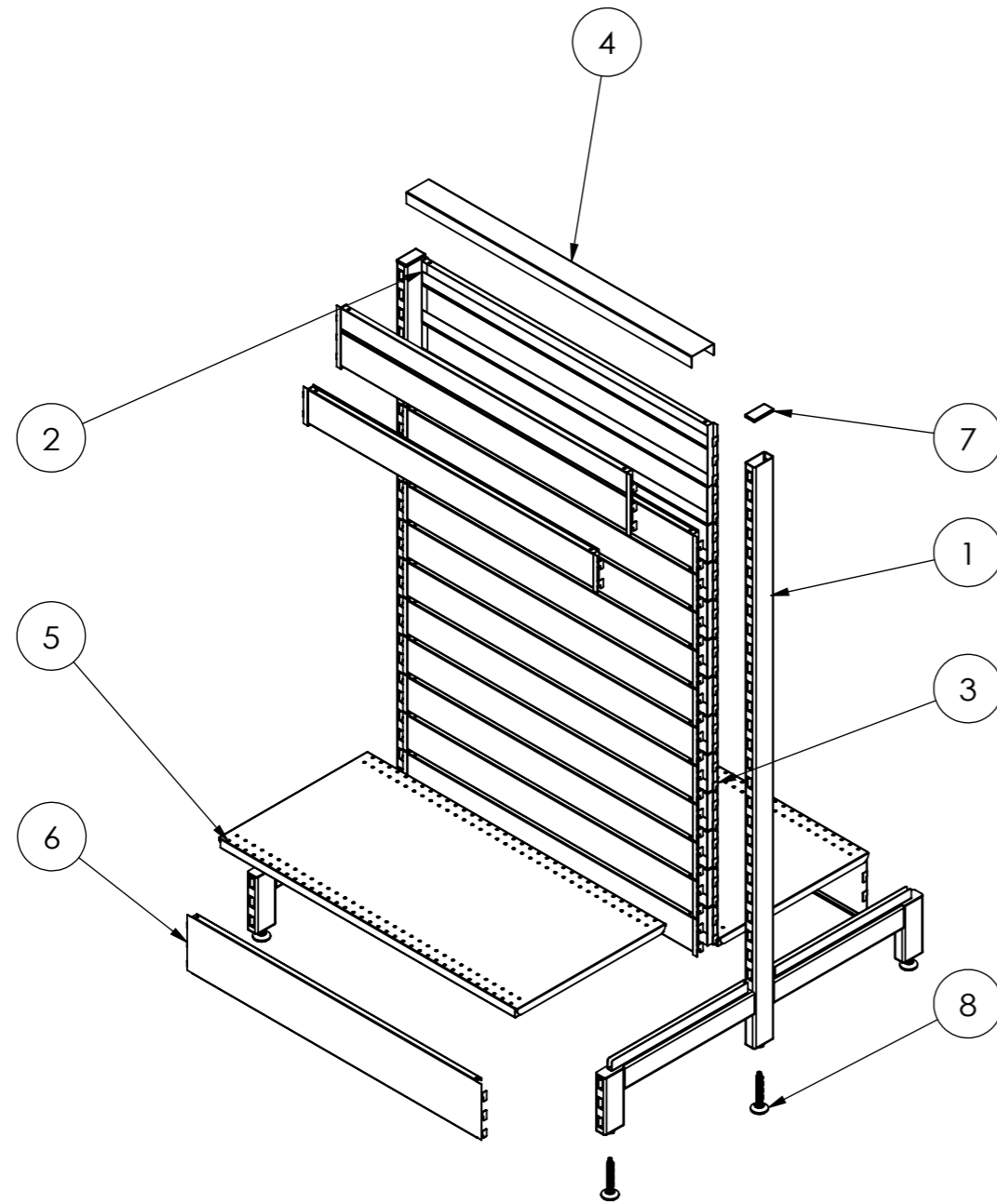

ITEM NO.	PRODUCT CODE	DESCRIPTION	FINISH	QTY.
1	RFA2331	POST - GONDOLA - DOUBLE SIDED - H1515XD900	P/C MATTE BLACK	2
2	RFA2319	CLIP IN PANEL - W900XH150 - SLAT WALL	P/C MATTE BLACK	2
3	RFA2316	CLIP IN PANEL - W900XH100 - SLAT WALL	P/C MATTE BLACK	24
4	RFA2334	TOP CAP - W900XH30 - W/. H30 RETURN FOLDS	P/C MATTE BLACK	1
5	RFA0411	SHELF - W900XD450 - W/. DOUBLE STIFFENER	P/C MATTE BLACK	2
6	RFA2322	900W X 150H SKIRT	P/C MATTE BLACK	2
7	-	PLASTIC ENDCAP	BLACK	2
8	-	ADJ. FEET OD38_M12_H70THD	RAW	6



T 03 8787 3000 F 03 8787 3025  
48-58 Cyber Loop, Dandenong South  
VIC 3175 (AUSTRALIA)

© COPYRIGHT. This drawing is the exclusive property of Associated Projects Pty Ltd. It is subject to protection and is strictly confidential. Reproduction in whole or in part is prohibited without obtaining prior permission in writing from the proprietor.

Rev	Date	Description

ALL DIMENSIONS IN (mm)  
UNLESS OTHERWISE SPECIFIED  
BREAK ALL SHARP EDGES

TOLERANCES  
(BEFORE PAINTING  
& AFTER PLATING)  
X ± 1.00  
X.X ± 0.50  
X.XX ± 0.10  
ANGLES ± 0.5°

A03- EXPLODED VIEW

CLIENT: -

PROJ. NO.: TBA

FINISH: P/C MATTE BLACK

MAT'L: Material <not specified>

Page 3

START BAY - DOUBLE SIDED GONDOLA - SOFT SHELL - W900XH1515XD450 - SLAT WALL

PRODUCT CODE: **RFA2044**

Date: 11/10/2023

Drawn by DH

Checked by NP

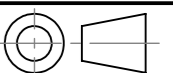

DO NOT SCALE

Scale@A3 1:15