



This product is an Add Bay
 * Supplied with (1) post only
 * Connects to the post of the neighboring Bay



T 03 8787 3000 F 03 8787 3025
 48-58 Cyber Loop, Dandenong South
 VIC 3175 (AUSTRALIA)

© COPYRIGHT. This drawing is the exclusive property of Associated Projects Pty Ltd. It is subject to protection and is strictly confidential. Reproduction in whole or in part is prohibited without obtaining prior permission in writing from the proprietor.

Rev	Date	Description

ALL DIMENSIONS IN (mm)
 UNLESS OTHERWISE SPECIFIED
 BREAK ALL SHARP EDGES

TOLERANCES
 (BEFORE PAINTING
 & AFTER PLATING)
 X ± 1.00
 X.X ± 0.50
 X.XX ± 0.10
 ANGLES ± 0.5°

A01- RENDER
CLIENT: -
PROJ. NO.: TBA
FINISH: P/C MATTE BLACK
MAT'L: VARIOUS
Page 1

ADD BAY - WALL BAY - CLIP IN GRAPHIC PANEL --
W600XH2400XD450

PRODUCT CODE: RFA2027		
Date:	30/10/2023	
Drawn by	DH	DO NOT SCALE
Checked by	NP	Scale@A3 1:20

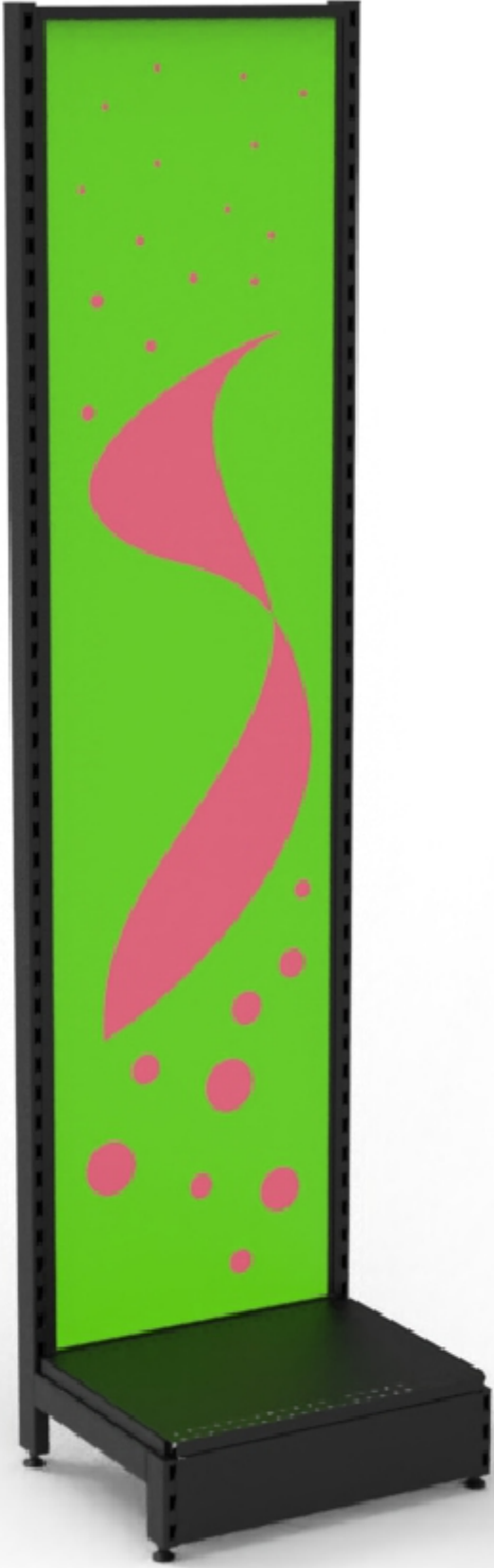

RENDER WITH INSERTED ARTWORK



T 03 8787 3000 F 03 8787 3025
 48-58 Cyber Loop, Dandenong South
 VIC 3175 (AUSTRALIA)

© COPYRIGHT. This drawing is the exclusive property of Associated Projects Pty Ltd. It is subject to protection and is strictly confidential. Reproduction in whole or in part is prohibited without obtaining prior permission in writing from the proprietor.

Rev	Date	Description

ALL DIMENSIONS IN (mm)
 UNLESS OTHERWISE SPECIFIED
 BREAK ALL SHARP EDGES

TOLERANCES
 (BEFORE PAINTING
 & AFTER PLATING)
 X ± 1.00
 X.X ± 0.50
 X.XX ± 0.10
 ANGLES ± 0.5°

A02- RENDER
CLIENT: -
PROJ. NO.: TBA
FINISH: P/C MATTE BLACK
MAT'L: VARIOUS
Page 2

ADD BAY - WALL BAY - CLIP IN GRAPHIC PANEL - -
W600XH2400XD450

PRODUCT CODE: RFA2027

Date: 30/10/2023

Drawn by DH

Checked by NP

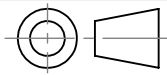

DO NOT SCALE

Scale@A3 1:20

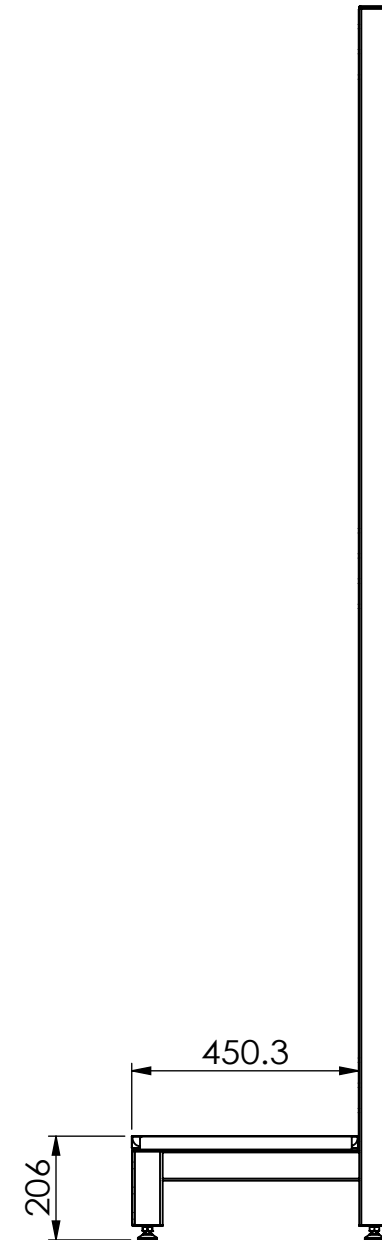
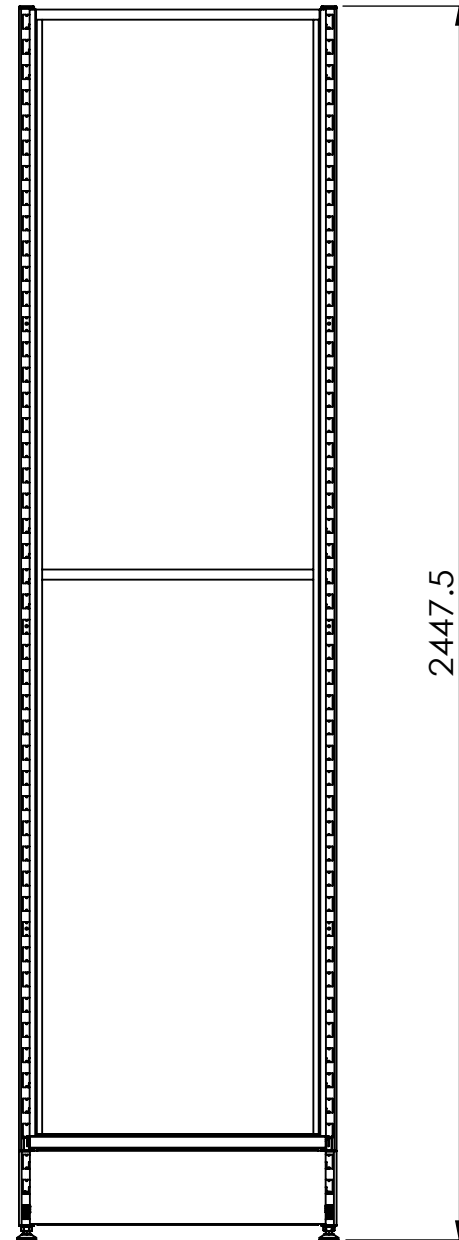
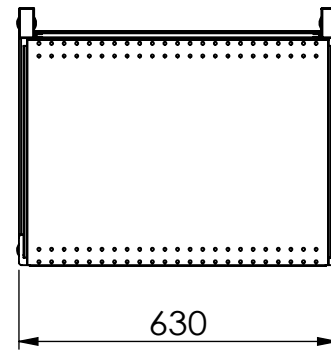
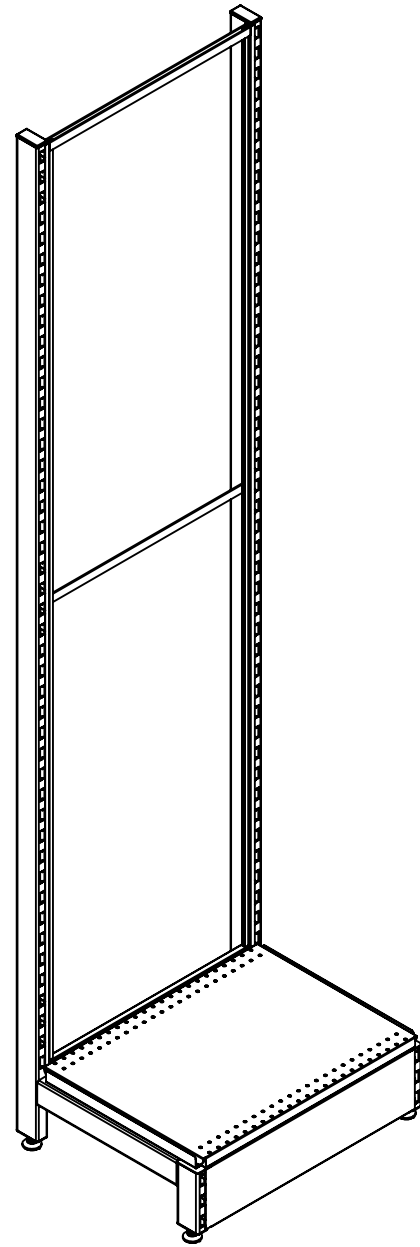

T 03 8787 3000 F 03 8787 3025
48-58 Cyber Loop, Dandenong South
VIC 3175 (AUSTRALIA)

© COPYRIGHT. This drawing is the exclusive property of Associated Projects Pty Ltd. It is subject to protection and is strictly confidential. Reproduction in whole or in part is prohibited without obtaining prior permission in writing from the proprietor.

Rev	Date	Description

ALL DIMENSIONS IN (mm)
UNLESS OTHERWISE SPECIFIED
BREAK ALL SHARP EDGES

TOLERANCES
(BEFORE PAINTING
& AFTER PLATING)
X ± 1.00
X.X ± 0.50
X.XX ± 0.10
ANGLES ± 0.5°

A03- CLIENT

CLIENT: -

PROJ. NO.: TBA

FINISH: P/C MATTE BLACK

MAT'L: VARIOUS

Page 3

ADD BAY - WALL BAY - CLIP IN GRAPHIC PANEL --
W600XH2400XD450

PRODUCT CODE: **RFA2027**

Date: 30/10/2023

Drawn by DH

Checked by NP

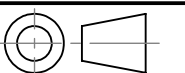

DO NOT SCALE

Scale@A3 1:15

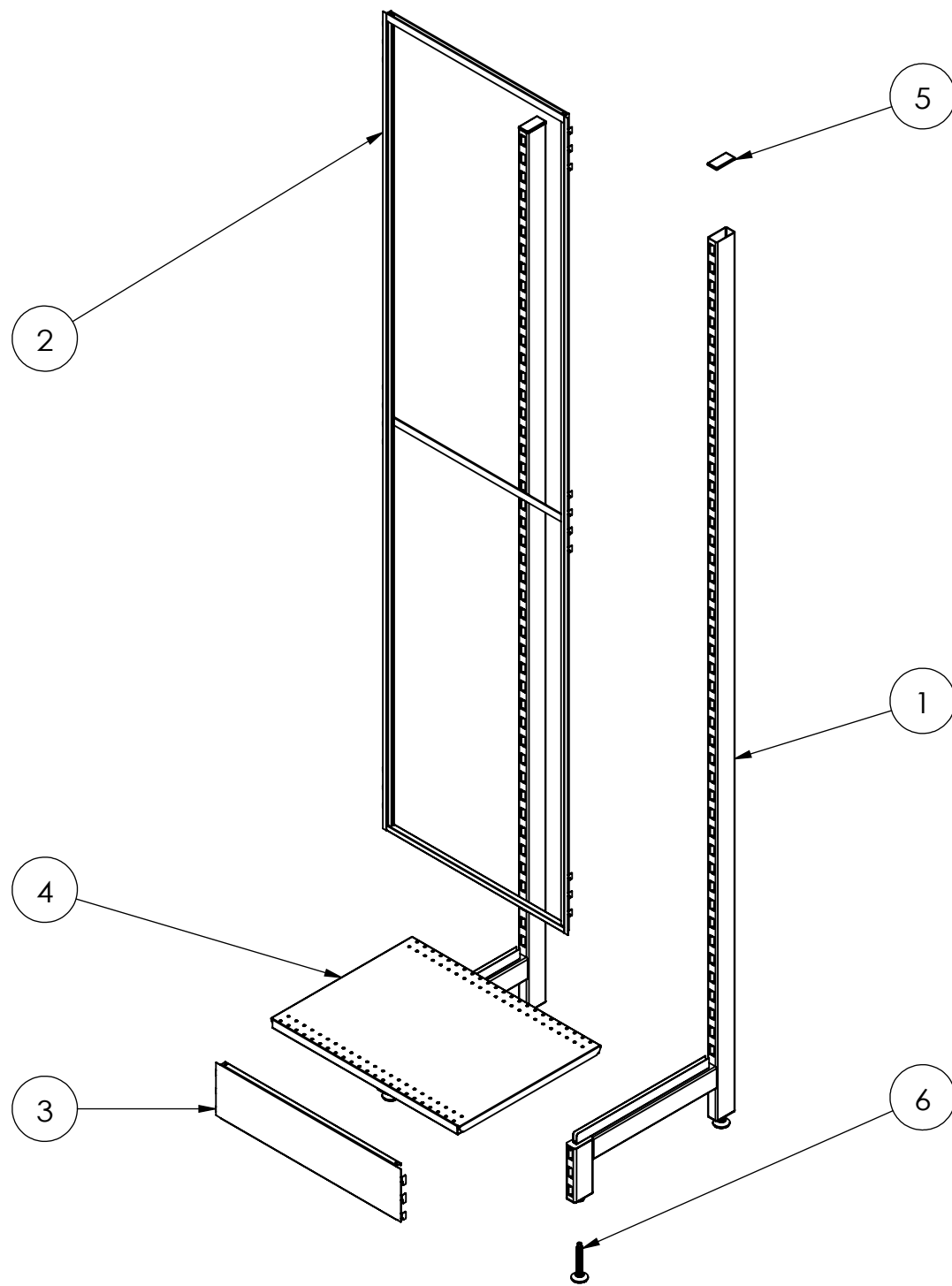

ITEM NO.	PRODUCT CODE	DESCRIPTION	FINISH	QTY.
1	RFA2302	POST - WALL BAY - H2400 - W/. LEG - HD	P/C MATTE BLACK	2
2	RFA2365	CLIP IN GRAPHIC FRAME - W600XH2250 - FOR CLIP IN GRAPHIC PANEL	P/C MATTE BLACK	1
3	RFA2321	600W X 150H SKIRT	P/C MATTE BLACK	1
4	RFA0408	SHELF - W600XD450 - W/. DOUBLE STIFFENER	P/C MATTE BLACK	1
5	-	PLASTIC ENDCAP	BLACK	2
6	-	ADJ. FEET OD38_M12_H70THD	RAW	4



T 03 8787 3000 F 03 8787 3025
48-58 Cyber Loop, Dandenong South
VIC 3175 (AUSTRALIA)

© COPYRIGHT. This drawing is the exclusive property of Associated Projects Pty Ltd. It is subject to protection and is strictly confidential. Reproduction in whole or in part is prohibited without obtaining prior permission in writing from the proprietor.

Rev	Date	Description

ALL DIMENSIONS IN (mm)
UNLESS OTHERWISE SPECIFIED
BREAK ALL SHARP EDGES

TOLERANCES
(BEFORE PAINTING
& AFTER PLATING)
X ± 1.00
X.X ± 0.50
X.XX ± 0.10
ANGLES ± 0.5°

A04- EXPLODED VIEW

CLIENT: -

PROJ. NO.: TBA

FINISH: P/C MATTE BLACK

MAT'L: VARIOUS

Page 4

ADD BAY - WALL BAY - CLIP IN GRAPHIC PANEL --
W600XH2400XD450

PRODUCT CODE: **RFA2027**

Date: 30/10/2023

Drawn by DH

Checked by NP

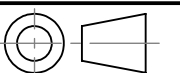

DO NOT SCALE

Scale@A3 1:15