

This product is an Add Bay

*Supplied with (1) post only
 *Add Bay connects to the post of the neighboring Bay

FINISH: P/C MATTE BLACK



T 03 8787 3000 F 03 8787 3025
 48-58 Cyber Loop, Dandenong South
 VIC 3175 (AUSTRALIA)

© COPYRIGHT. This drawing is the exclusive property of Associated Projects Pty Ltd. It is subject to protection and is strictly confidential. Reproduction in whole or in part is prohibited without obtaining prior permission in writing from the proprietor.

Rev	Date	Description

ALL DIMENSIONS IN (mm)
 UNLESS OTHERWISE SPECIFIED
 BREAK ALL SHARP EDGES

TOLERANCES
 (BEFORE PAINTING
 & AFTER PLATING)
 X ± 1.00
 X.X ± 0.50
 X.XX ± 0.10
 ANGLES ± 0.5°

A01- RENDER
CLIENT: -
PROJ. NO.: TBA
FINISH: P/C MATTE BLACK
MAT'L: VARIOUS
Page 1

ADD BAY - WALL BAY - SOFT SHELL - PERFORATED
W600 x H2400 x D450

PRODUCT CODE: RFA2003

Date: 3/07/2024

Drawn by DH

Checked by NP

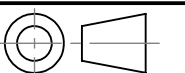

DO NOT SCALE

Scale@A3 1:20

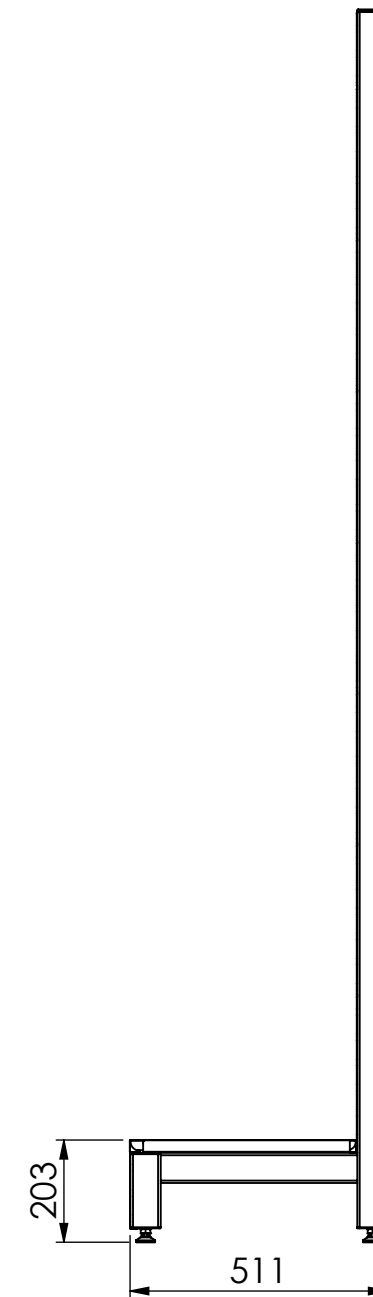
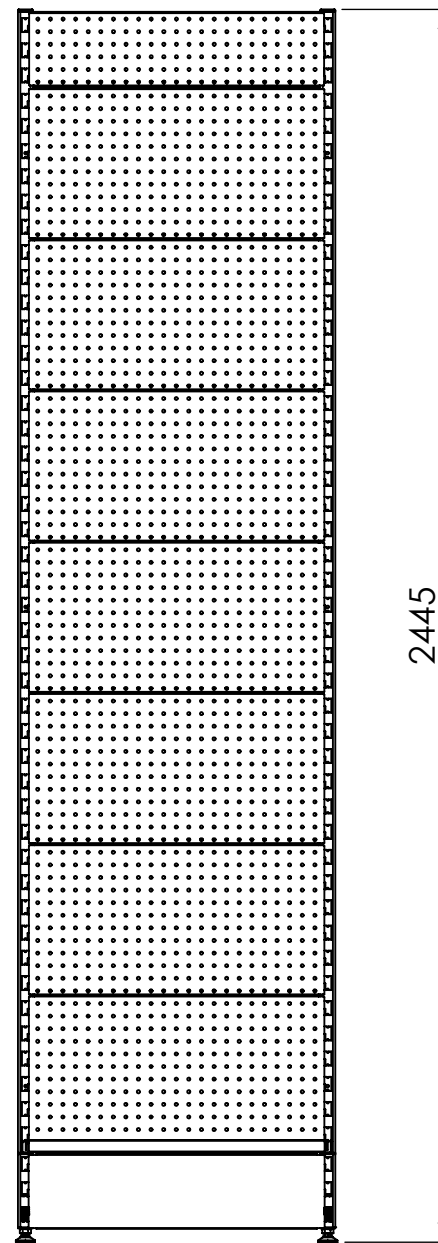
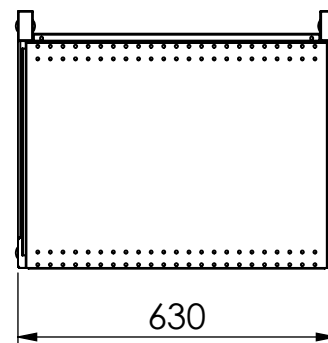
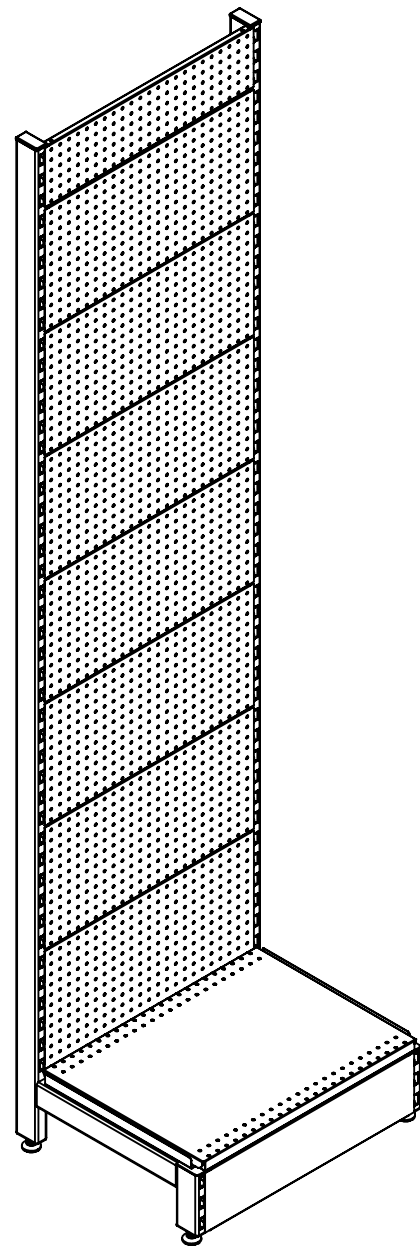

T 03 8787 3000 F 03 8787 3025
 48-58 Cyber Loop, Dandenong South
 VIC 3175 (AUSTRALIA)

© COPYRIGHT. This drawing is the exclusive property of Associated Projects Pty Ltd. It is subject to protection and is strictly confidential. Reproduction in whole or in part is prohibited without obtaining prior permission in writing from the proprietor.

Rev	Date	Description

ALL DIMENSIONS IN (mm)
 UNLESS OTHERWISE SPECIFIED
 BREAK ALL SHARP EDGES

TOLERANCES
 (BEFORE PAINTING
 & AFTER PLATING)
 X ± 1.00
 X.X ± 0.50
 X.XX ± 0.10
 ANGLES ± 0.5°

A02- CLIENT
 CLIENT: -
 PROJ. NO.: TBA
 FINISH: P/C MATTE BLACK
 MAT'L: VARIOUS
 Page 2

ADD BAY - WALL BAY - SOFT SHELL - PERFORATED
 W600 x H2400 x D450

PRODUCT CODE: **RFA2003**

Date: 3/07/2024

Drawn by DH

Checked by NP

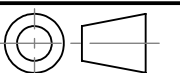

DO NOT SCALE

Scale@A3 1:15

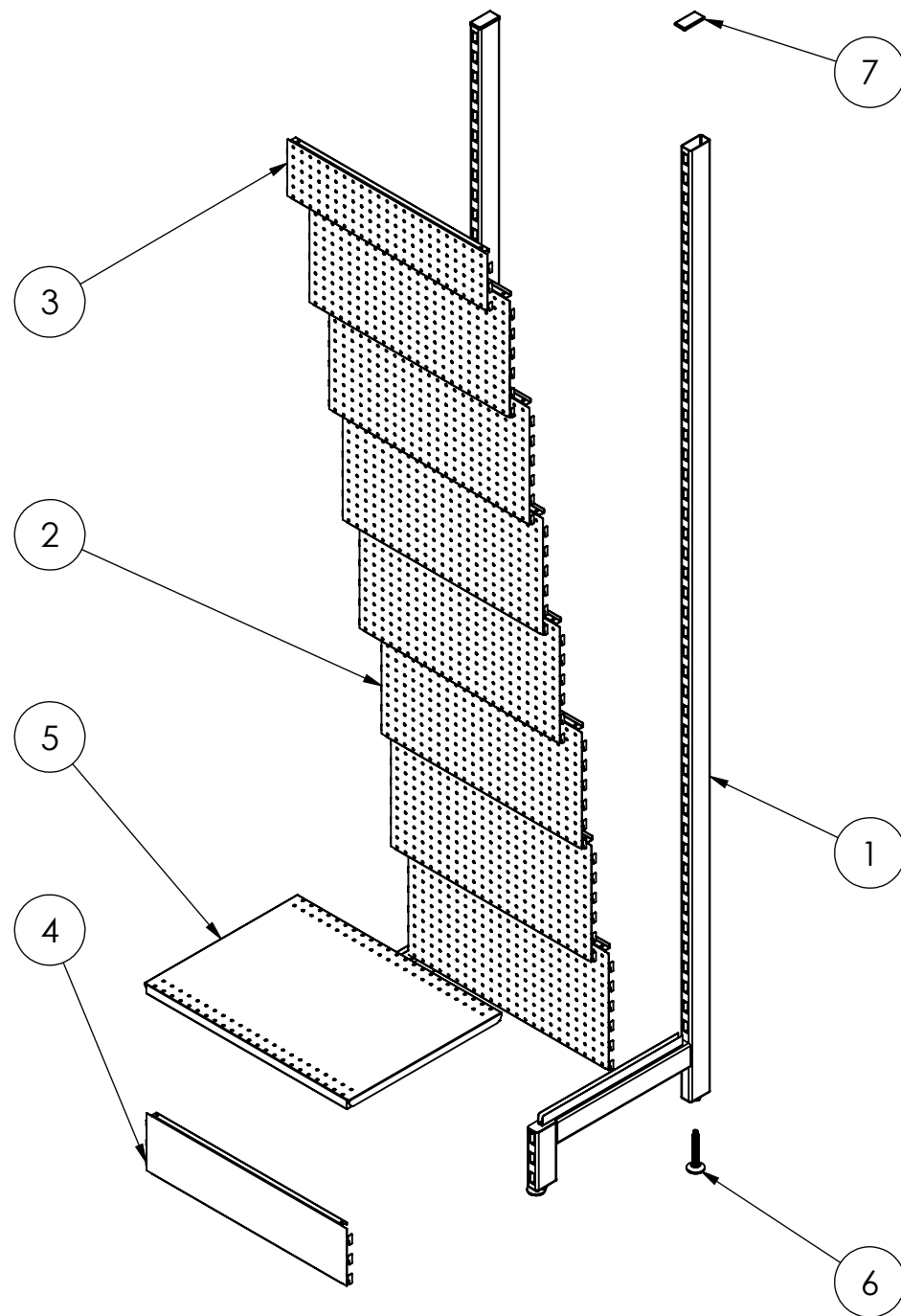

ITEM NO.	PRODUCT CODE	DESCRIPTION	FINISH	QTY.
1	RFA2302	POST - WALL BAY - H2400 - W/. LEG - HD	P/C MATTE BLACK	2
2	RFA2306	CLIP IN PANEL - W600XH300 - PERFORATED	P/C MATTE BLACK	7
3	RFA2303	CLIP IN PANEL - W600XH150 - PERFORATED	P/C MATTE BLACK	1
4	RFA2321	W600 X H150 SKIRT	P/C MATTE BLACK	1
5	RFA0408	SHELF - W600XD450 - W/. DOUBLE STIFFENER	P/C MATTE BLACK	1
6	-	ADJ. FEET OD38_M12_H70THD	RAW	4
7	-	PLASTIC ENDCAP	BLACK	2



T 03 8787 3000 F 03 8787 3025
48-58 Cyber Loop, Dandenong South
VIC 3175 (AUSTRALIA)

© COPYRIGHT. This drawing is the exclusive property of Associated Projects Pty Ltd. It is subject to protection and is strictly confidential. Reproduction in whole or in part is prohibited without obtaining prior permission in writing from the proprietor.

Rev	Date	Description

ALL DIMENSIONS IN (mm)
UNLESS OTHERWISE SPECIFIED
BREAK ALL SHARP EDGES

TOLERANCES
(BEFORE PAINTING
& AFTER PLATING)
X ± 1.00
X.X ± 0.50
X.XX ± 0.10
ANGLES ± 0.5°

A03- EXPLODED VIEW

CLIENT: -

PROJ. NO.: TBA

FINISH: P/C MATTE BLACK

MAT'L: VARIOUS

Page 3

ADD BAY - WALL BAY - SOFT SHELL - PERFORATED
W600 x H2400 x D450

PRODUCT CODE: **RFA2003**

Date: 3/07/2024

Drawn by DH

Checked by NP

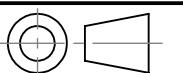

DO NOT SCALE

Scale@A3 1:15