

This product is an Add Bay
 * Supplied with (1) post only
 * Connects to the post of the neighboring Bay

| Rev | Date | Description |
|-----|------|-------------|
| | | |
| | | |
| | | |
| | | |

ALL DIMENSIONS IN (mm)
 UNLESS OTHERWISE SPECIFIED
 BREAK ALL SHARP EDGES

TOLERANCES
 (BEFORE PAINTING
 & AFTER PLATING)
 X ± 1.00
 X.X ± 0.50
 X.XX ± 0.10
 ANGLES ± 0.5°

A01- RENDER
 CLIENT: RFA1000
 PROJ. NO.: TBA
 PART NO.: --
 Revision --
 Page 1

| | | |
|--|------------------|--------------|
| RFA1073 600(W) X 1515 (H) DOUBLE SIDED GONDOLA BAY-PERFORATED - ADD BAY | | |
| PRODUCT CODE: RFA1073 | Date: 26/10/2022 | |
| Drawn by: DH | Checked by: -- | DO NOT SCALE |
| Scale@A3 1:20 | | |

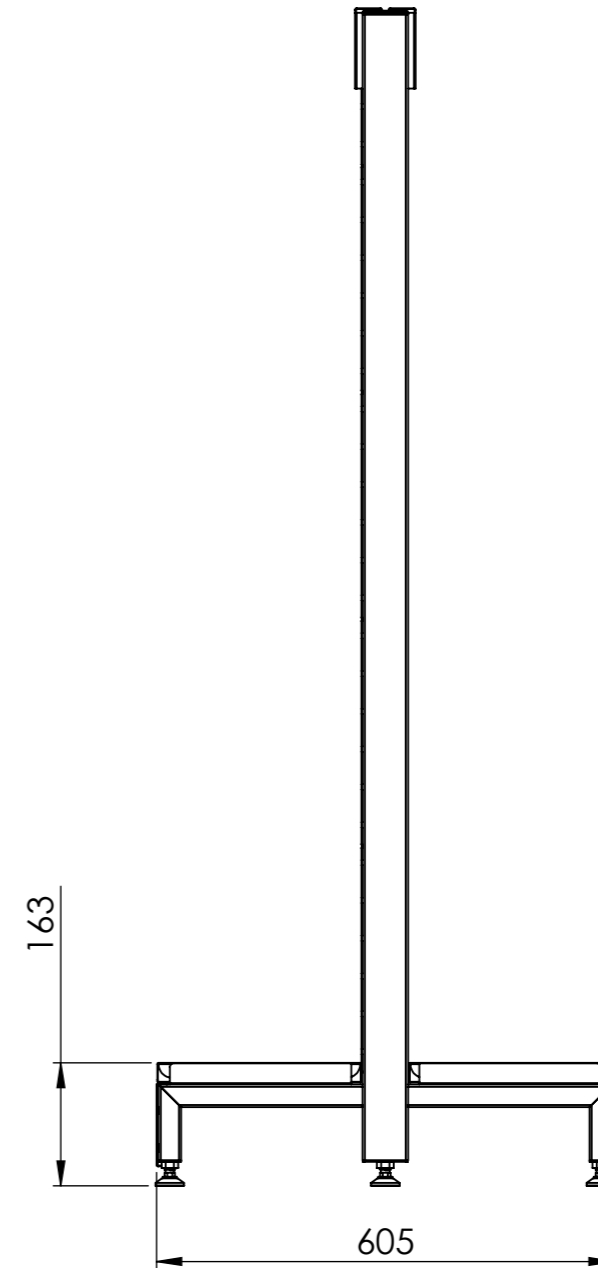
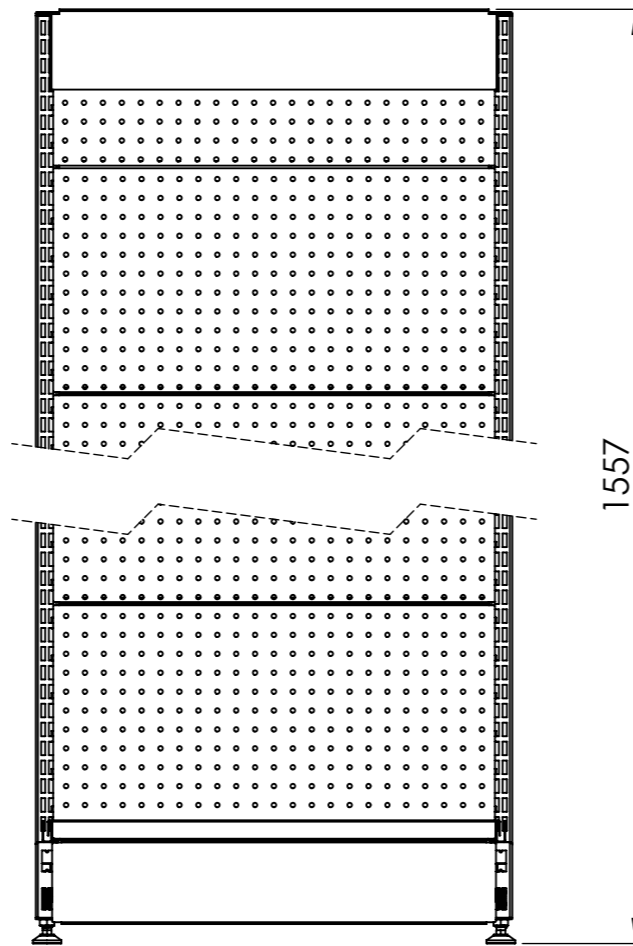
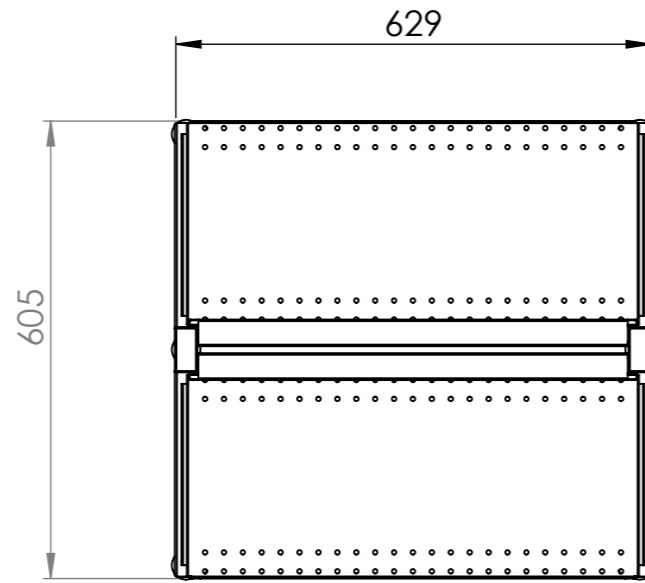
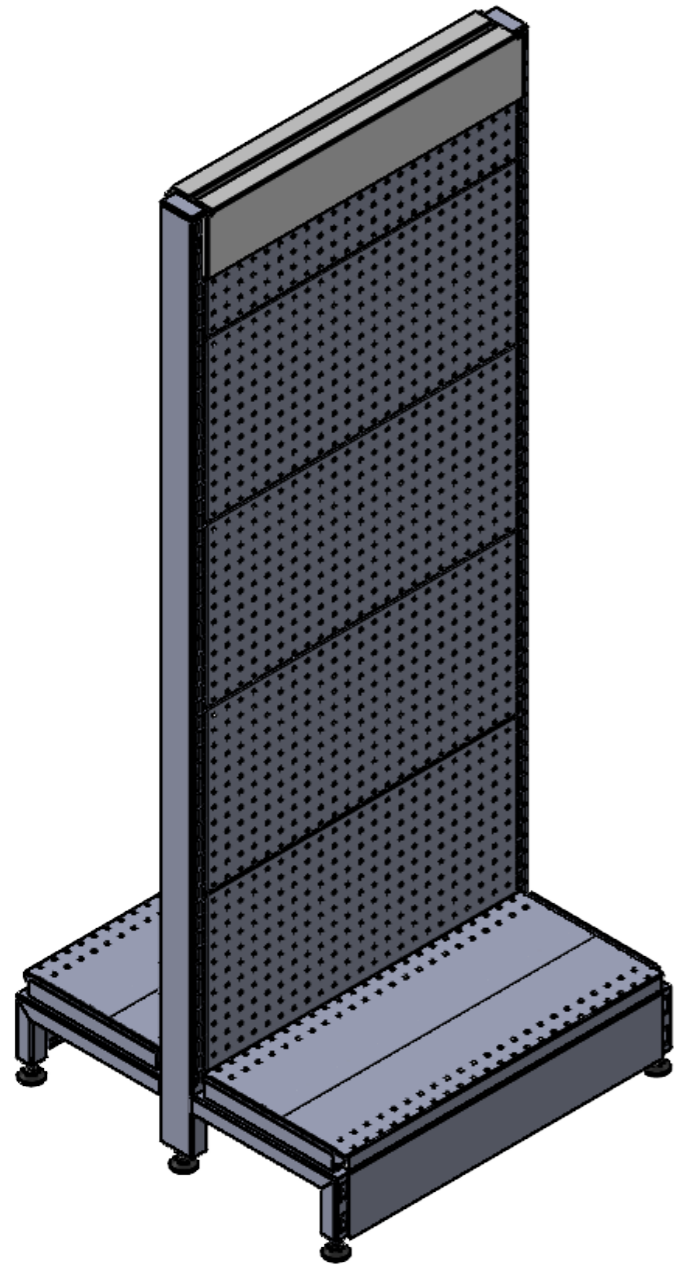

| Rev | Date | Description |
|-----|------|-------------|
| | | |
| | | |
| | | |

ALL DIMENSIONS IN (mm)
UNLESS OTHERWISE SPECIFIED
BREAK ALL SHARP EDGES

TOLERANCES
(BEFORE PAINTING
& AFTER PLATING)
X ± 1.00
X.X ± 0.50
X.XX ± 0.10
ANGLES ± 0.5°

A02- RENDER
CLIENT: RFA1000
PROJ. NO.: TBA
PART NO.: --
Revision --
Page 2

RFA1073 600(W) X 1515 (H) DOUBLE
SIDED GONDOLA BAY-PERFORATED -
ADD BAY

PRODUCT CODE: RFA1073

Date: 26/10/2022

Drawn by DH

Checked by --

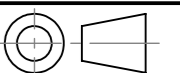

DO NOT SCALE

Scale@A3 1:15

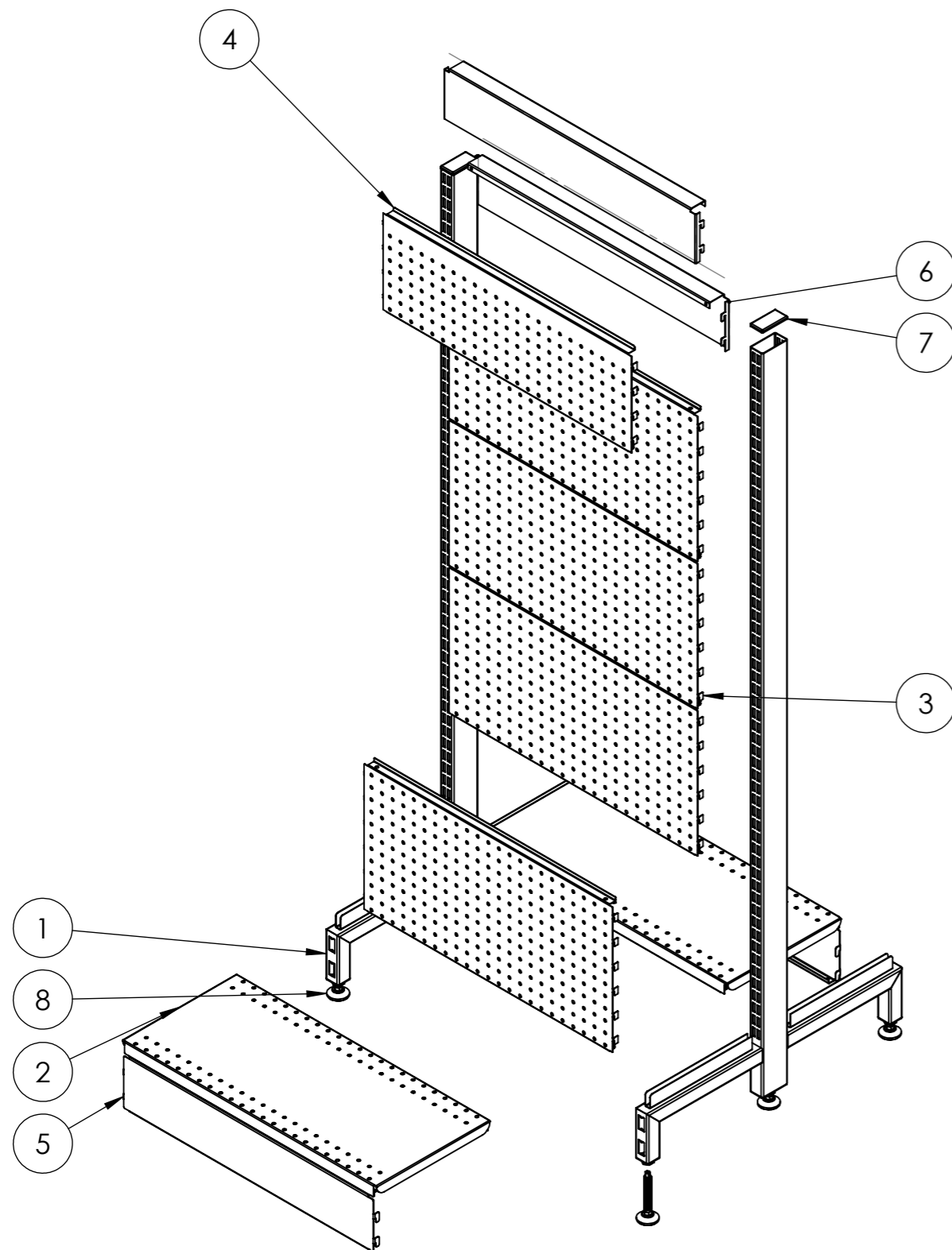

| ITEM NO. | DESCRIPTION | QTY. |
|----------|-------------------------|------|
| 1 | DOUBLE SIDED POST | 2 |
| 2 | 600X270 SHELF | 2 |
| 3 | 600W x 300H PERF PANEL | 4 |
| 4 | 600W X 200H PERF. PANEL | 1 |
| 5 | BOTTOM SKIRT | 2 |
| 6 | SNAP IN TOP CAP | 2 |
| 7 | PLASTIC ENDCAP | 2 |
| 8 | ADJ. FEET | 6 |

| Rev | Date | Description |
|-----|------|-------------|
| | | |
| | | |
| | | |

ALL DIMENSIONS IN (mm)
UNLESS OTHERWISE SPECIFIED
BREAK ALL SHARP EDGES

TOLERANCES
(BEFORE PAINTING
& AFTER PLATING)
X ± 1.00
X.X ± 0.50
X.XX ± 0.10
ANGLES ± 0.5°

A09- EXPLODED
CLIENT: RFA1000
PROJ. NO.: TBA
PART NO.: --
Revision --
Page 9

RFA1073 600(W) X 1515 (H) DOUBLE
SIDED GONDOLA BAY-PERFORATED -
ADD BAY

PRODUCT CODE: **RFA1073**

Date: 26/10/2022

Drawn by DH

Checked by --

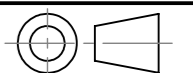

DO NOT SCALE

Scale@A3 1:20