

Rev	Date	Description

ALL DIMENSIONS IN (mm)
UNLESS OTHERWISE SPECIFIED
BREAK ALL SHARP EDGES

TOLERANCES
(BEFORE PAINTING
& AFTER PLATING)
X ± 1.00
X.X ± 0.50
X.XX ± 0.10
ANGLES ± 0.5°

A02- RENDER
CLIENT: RFA
PROJ. NO.: TBA
PART NO.: --
Revision --
Page 2

900mm (W) x 2415mm (H) x 270mm (D) WALL BAY - NON PERFORATED W/. SKIRT DRAWER START BAY (MATTE BLACK)		
PRODUCT CODE: RFA1071 Date: 31/10/2022 Drawn by PS Checked by --		
		DO NOT SCALE
		Scale@A3 1:10

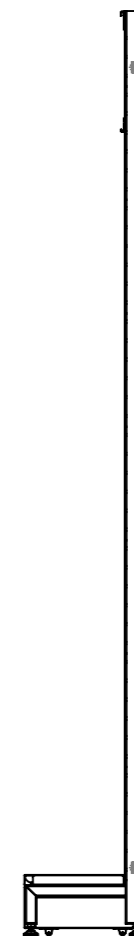
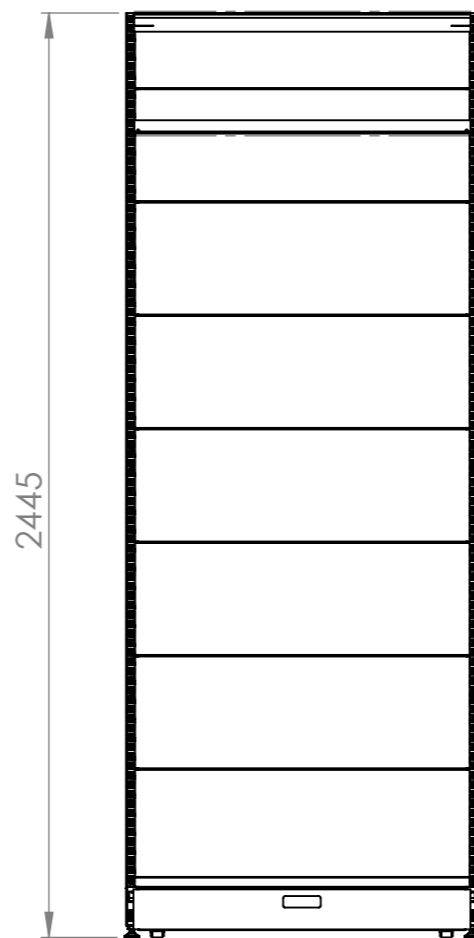
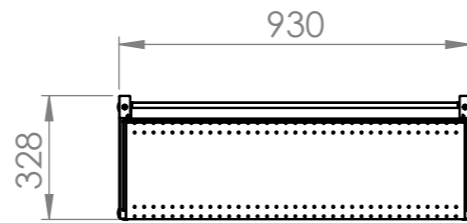
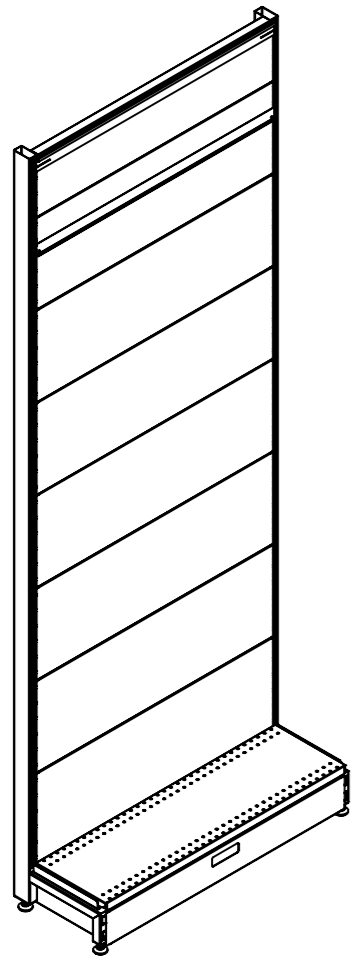

Rev	Date	Description

ALL DIMENSIONS IN (mm)
UNLESS OTHERWISE SPECIFIED
BREAK ALL SHARP EDGES

TOLERANCES
(BEFORE PAINTING
& AFTER PLATING)
X ± 1.00
X.X ± 0.50
X.XX ± 0.10
ANGLES ± 0.5°

A03- DIMENSIONS

CLIENT: RFA
PROJ. NO.: TBA
PART NO.: --
Revision --
Page 3

900mm (W) x 2415mm (H) x 270mm (D)
WALL BAY - NON PERFORATED W/ SKIRT DRAWER
START BAY

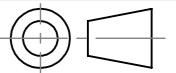
PRODUCT CODE: RFA1014/1071		
Date:	31/10/2022	
Drawn by	PS	DO NOT SCALE
Checked by	--	Scale@A3 1:20

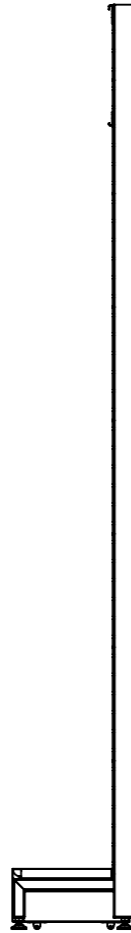
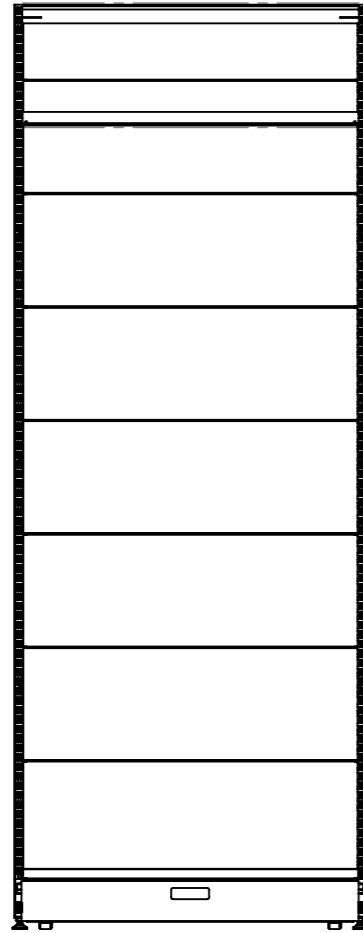
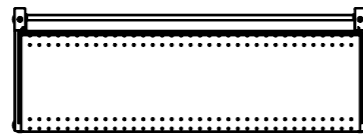
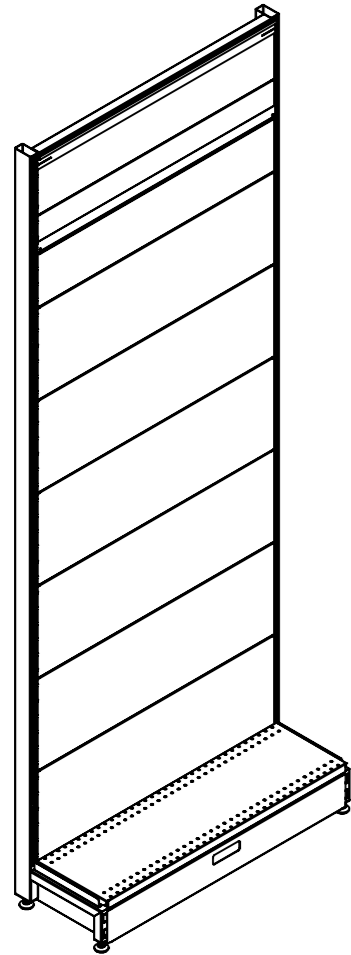

ITEM NO.	PartNo	DESCRIPTION	QTY.
1	RFA1100	2400mm (H) WALL BAY POST	2
2	RFA1323-RFA1324	900mm (W) x 270mm (D) STEEL SHELF	1
3	RFA1102-RFA1202	900mm (W) x 300mm (H) PERF. PANEL	7
4	RFA1104-RFA1204	900mm (W) x 200mm (H) PERF. PANEL	1
5	RFA1118	900mm (W) SIGNAGE TOP BRACKET	1
6	RFA1119	900mm (W) SIGNAGE BOTTOM BRACKET	1
7		900mm (W) SKIRT DRAWER	1

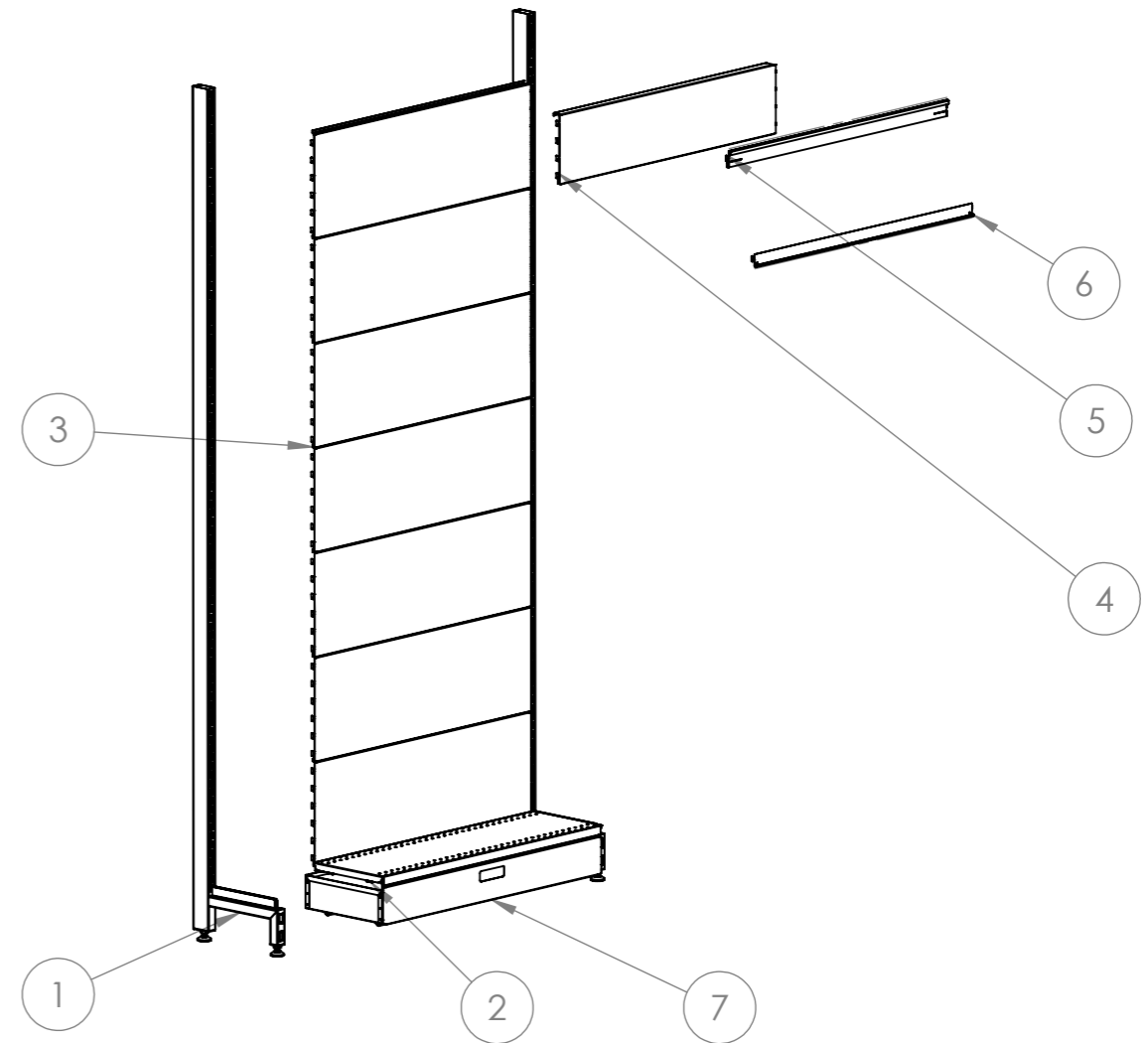

Rev	Date	Description

ALL DIMENSIONS IN (mm)
UNLESS OTHERWISE SPECIFIED
BREAK ALL SHARP EDGES

TOLERANCES
(BEFORE PAINTING
& AFTER PLATING)
X ± 1.00
X.X ± 0.50
X.XX ± 0.10
ANGLES ± 0.5°

A04- EXPLODED

CLIENT: RFA
PROJ. NO.: TBA
PART NO.: --
Revision --
Page 4

900mm (W) x 2415mm (H) x 270mm (D)
WALL BAY - NON PERFORATED W/ SKIRT DRAWER
START BAY

PRODUCT CODE: **RFA1014/1071**

Date: 31/10/2022

Drawn by PS

Checked by --

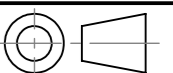

DO NOT SCALE

Scale@A3 1:20