

This Product is an Add Bay  
 \* Supplied with (1) post only  
 \* Connects to the post of the neighboring Bay

Rev	Date	Description

ALL DIMENSIONS IN (mm)  
 UNLESS OTHERWISE SPECIFIED  
 BREAK ALL SHARP EDGES

TOLERANCES  
 (BEFORE PAINTING  
 & AFTER PLATING)  
 X ± 1.00  
 X.X ± 0.50  
 X.XX ± 0.10  
 ANGLES ± 0.5°

**A02- RENDER**  
**CLIENT: RFA**  
**PROJ. NO.: TBA**  
**PART NO.: --**  
**Revision --**  
**Page 2**

900mm (W) x 2415mm (H) 270mm (D) WALL BAY - PERFORATED ADD BAY (MATTE BLACK)		
<b>PRODUCT CODE: RFA1062</b> Date: 28/10/2022 Drawn by CB Checked by --		
		DO NOT SCALE
		Scale@A3 1:1

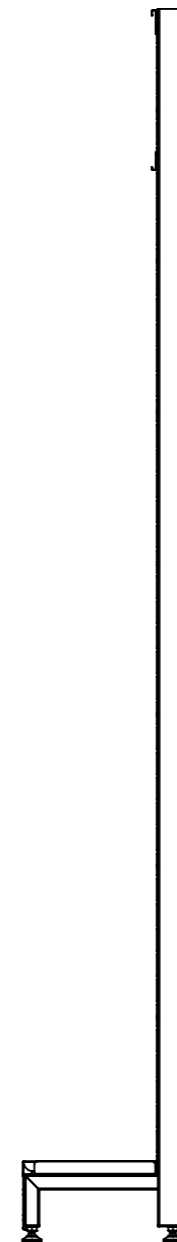
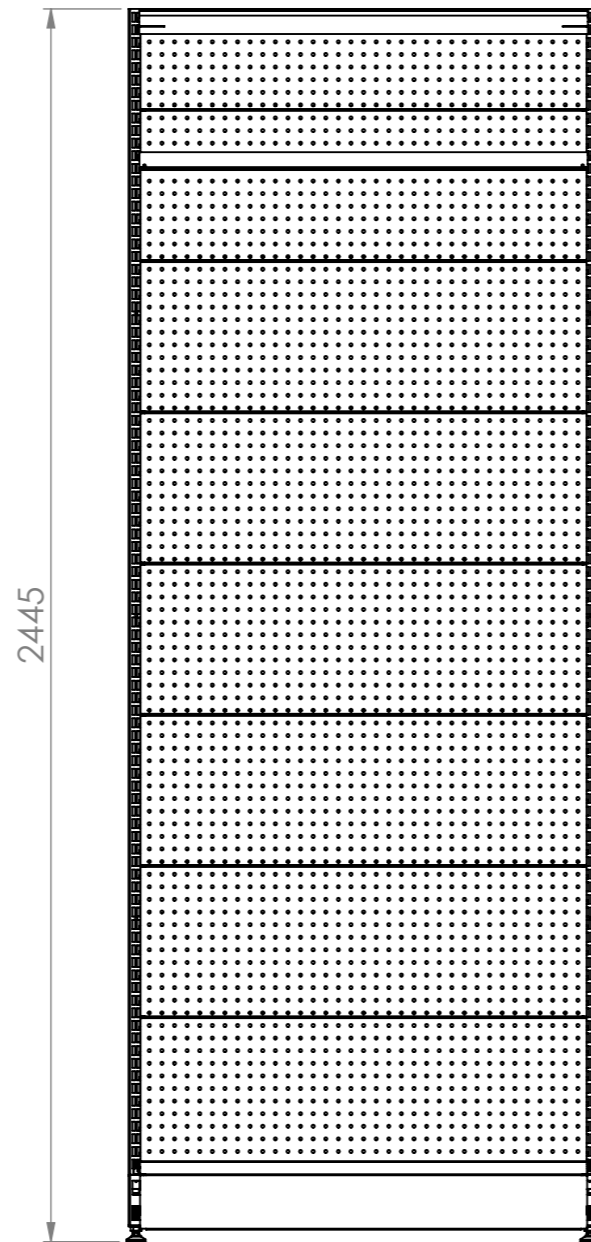
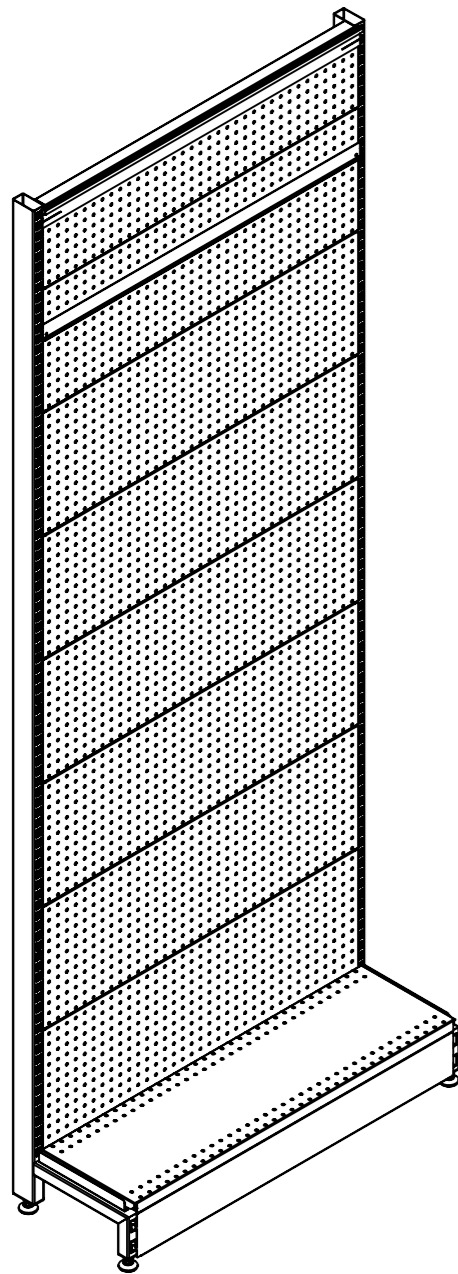

Rev	Date	Description

ALL DIMENSIONS IN (mm)  
UNLESS OTHERWISE SPECIFIED  
BREAK ALL SHARP EDGES

TOLERANCES  
(BEFORE PAINTING  
& AFTER PLATING)  
X ± 1.00  
X.X ± 0.50  
X.XX ± 0.10  
ANGLES ± 0.5°

**A03- DIMENSIONS**

CLIENT: RFA  
PROJ. NO.: TBA  
PART NO.: --  
Revision --  
Page 3

900mm (W) x 2415mm (H) x 270mm (D)  
WALL BAY - PERFORATED  
ADD BAY

PRODUCT CODE: **RFA1062**

Date: 28/10/2022

Drawn by CB

Checked by --

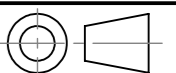

DO NOT SCALE

Scale@A3 1:15

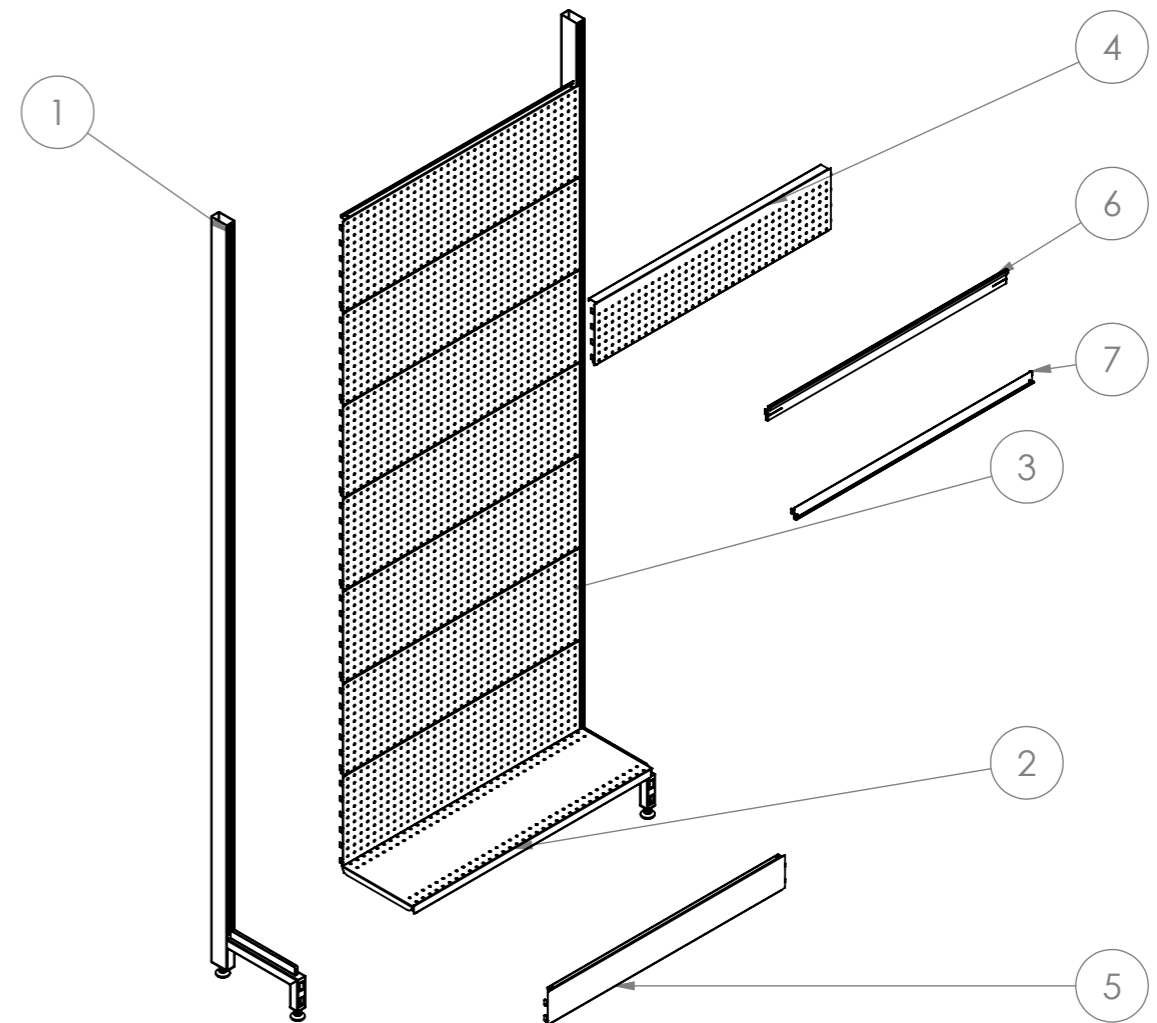
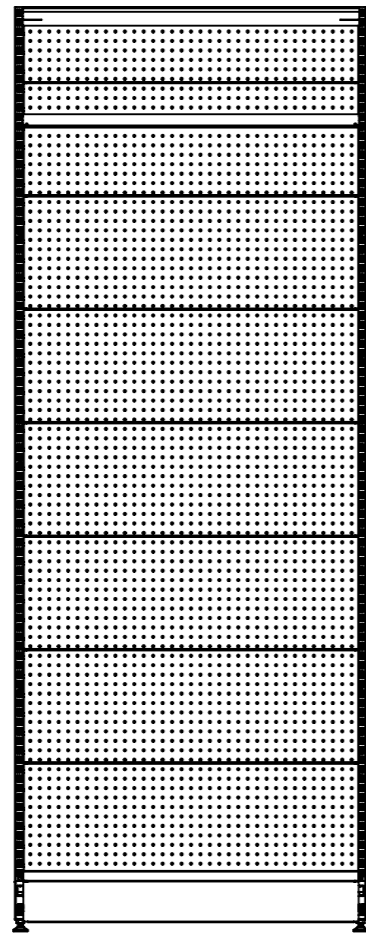
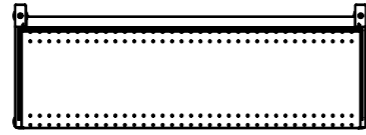
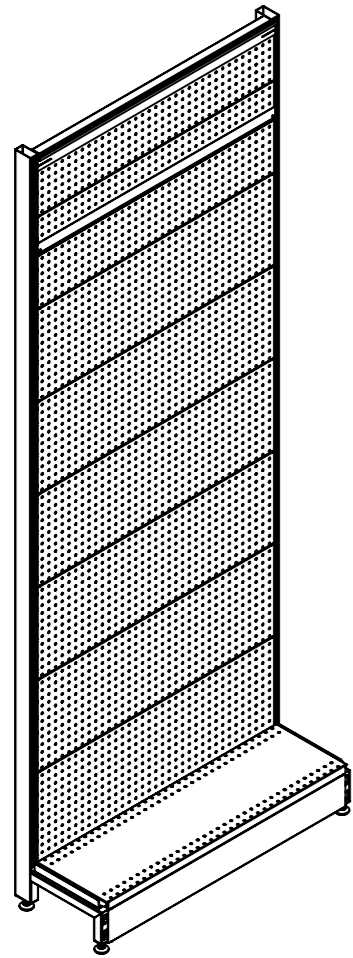

ITEM NO.	PART NUMBER	QTY.
1	RFA1100 2400mm (H) WALL BAY POST	2
2	RFA1323-RFA1324 900X270 STEEL SHELF	1
3	RFA1102-RFA1202 900X300 PERF PANEL	7
4	RFA1104-RFA1204 900X200 PERF PANEL	1
5	RFA1110-RFA1210 SKIRT	1
6	RFA1118 900mm (W) SIGNAGE TOP BRACKET	1
7	RFA1119 900mm (W) SIGNAGE BOTTOM BRACKET	1

Rev	Date	Description

ALL DIMENSIONS IN (mm)  
UNLESS OTHERWISE SPECIFIED  
BREAK ALL SHARP EDGES

TOLERANCES  
(BEFORE PAINTING  
& AFTER PLATING)  
X ± 1.00  
X.X ± 0.50  
X.XX ± 0.10  
ANGLES ± 0.5°

A04- EXPLODED

CLIENT: RFA

PROJ. NO.: TBA

PART NO.: --

Revision --

Page 4

900mm (W) x 2415mm (H) x 270mm (D)  
WALL BAY - PERFORATED  
ADD BAY

PRODUCT CODE: **RFA1062**

Date: 28/10/2022

Drawn by CB

Checked by --

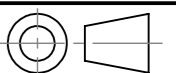

DO NOT SCALE

Scale@A3 1:20