

Rev	Date	Description

ALL DIMENSIONS IN (mm)
UNLESS OTHERWISE SPECIFIED
BREAK ALL SHARP EDGES

TOLERANCES
(BEFORE PAINTING
& AFTER PLATING)
X ± 1.00
X.X ± 0.50
X.XX ± 0.10
ANGLES ± 0.5°

A02- RENDER
CLIENT: RFA
PROJ. NO.: TBA
PART NO.: --
Revision --
Page 2

900mm (W) x 2415mm (H) 270mm (D)		
WALL BAY - PERFORATED		
START BAY (MATTE BLACK)		DO NOT SCALE
PRODUCT CODE: RFA1061		
Date:	28/10/2022	
Drawn by	CB	
Checked by	--	Scale@A3 1:1

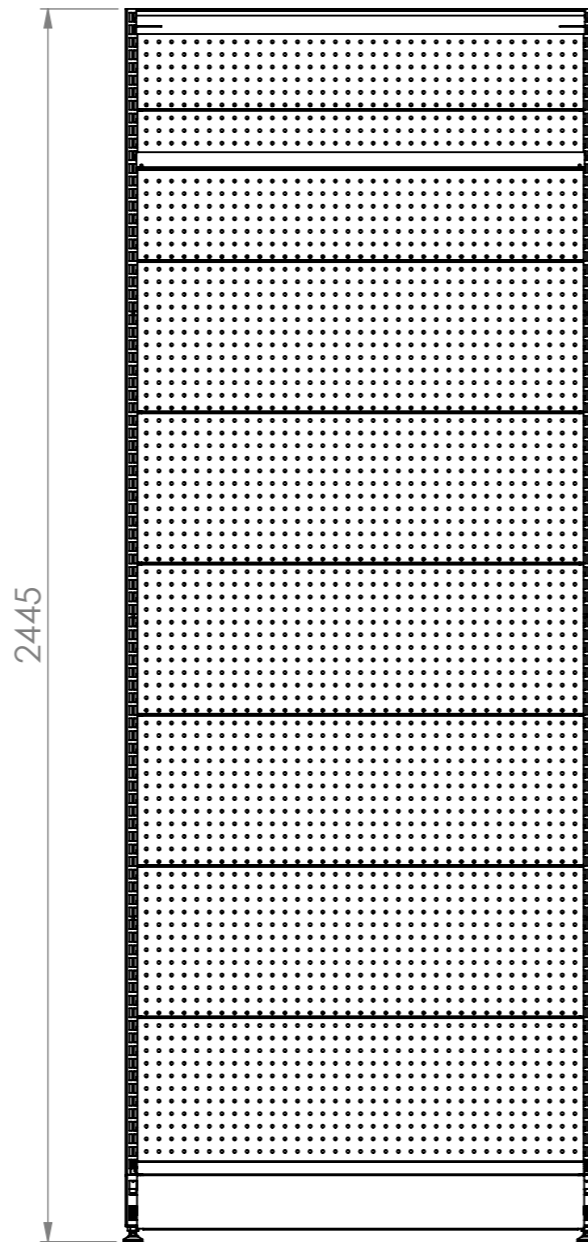
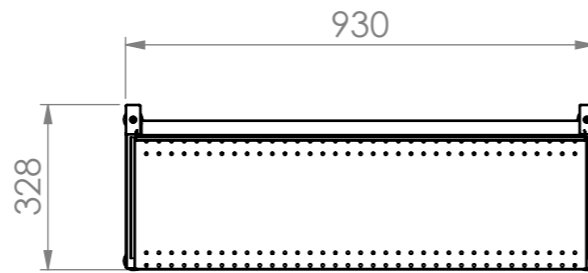
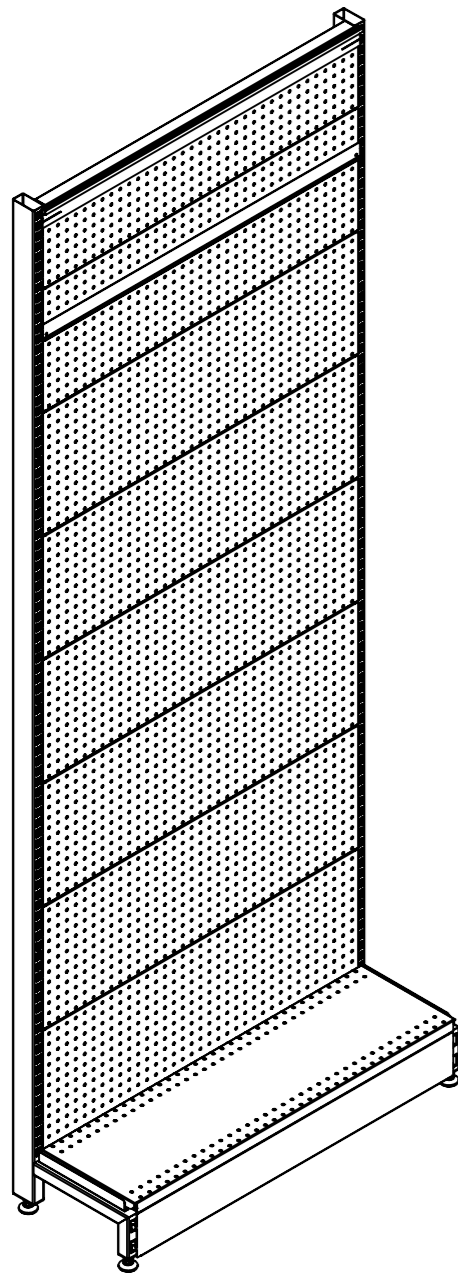

Rev	Date	Description

ALL DIMENSIONS IN (mm)
UNLESS OTHERWISE SPECIFIED
BREAK ALL SHARP EDGES

TOLERANCES
(BEFORE PAINTING
& AFTER PLATING)
X ± 1.00
X.X ± 0.50
X.XX ± 0.10
ANGLES ± 0.5°

A03- DIMENSIONS

CLIENT: RFA
PROJ. NO.: TBA
PART NO.: --
Revision --
Page 3

900mm (W) x 2415mm (H) x 270mm (D)
WALL BAY - PERFORATED
START BAY

PRODUCT CODE: **RFA1004/RFA1061**

Date: 28/10/2022

Drawn by CB

Checked by --

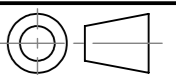

DO NOT SCALE

Scale@A3 1:15

ITEM NO.	PART NUMBER	QTY.
1	RFA1100 2400mm (H) WALL BAY POST	2
2	RFA1323-RFA1324 900X270 STEEL SHELF	1
3	RFA1102-RFA1202 900X300 PERF PANEL	7
4	RFA1104-RFA1204 900X200 PERF PANEL	1
5	RFA1110-RFA1210 SKIRT	1
6	RFA1118 900mm (W) SIGNAGE TOP BRACKET	1
7	RFA1119 900mm (W) SIGNAGE BOTTOM BRACKET	1

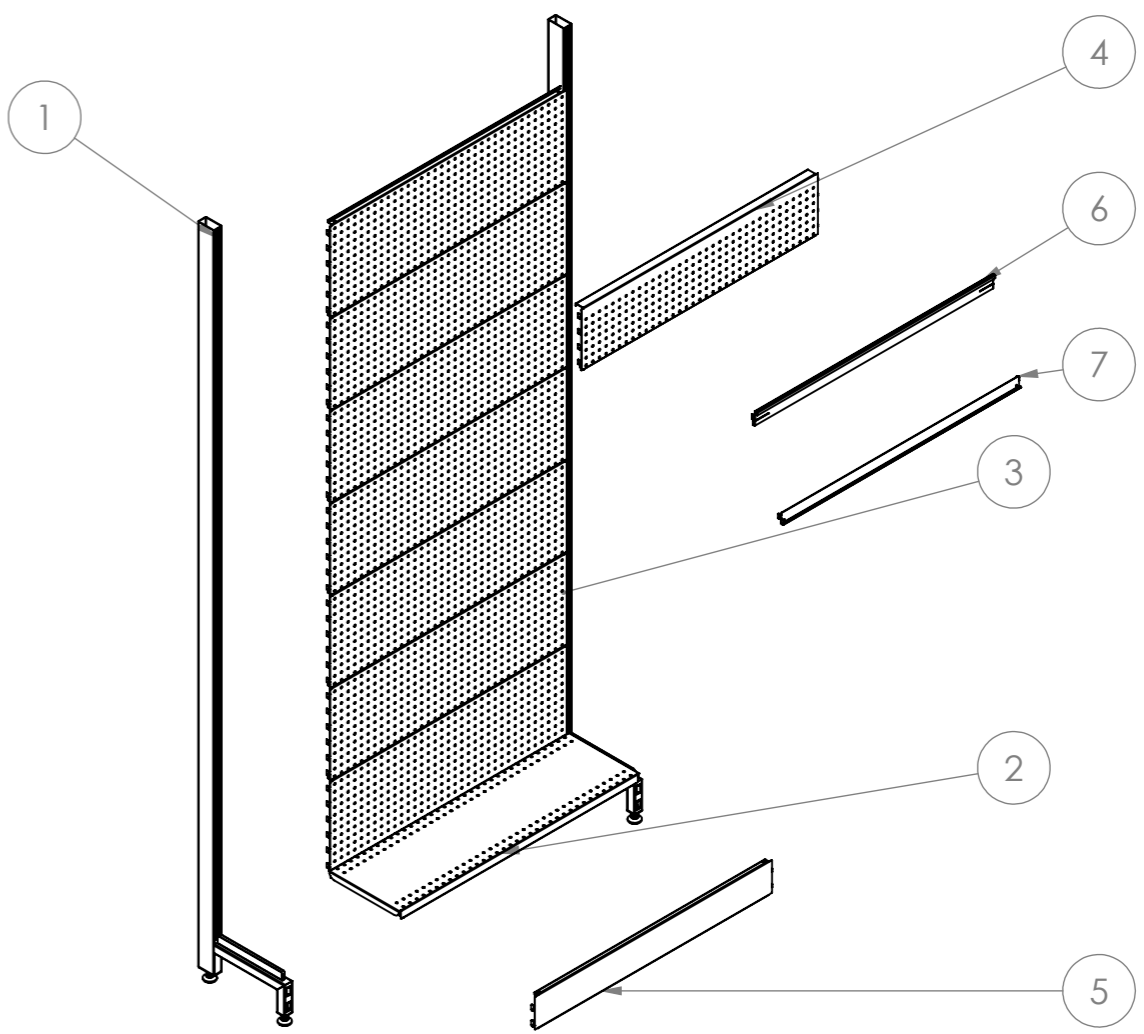
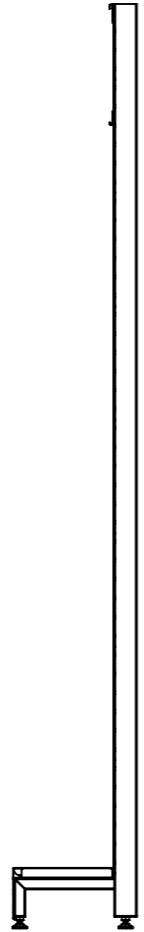
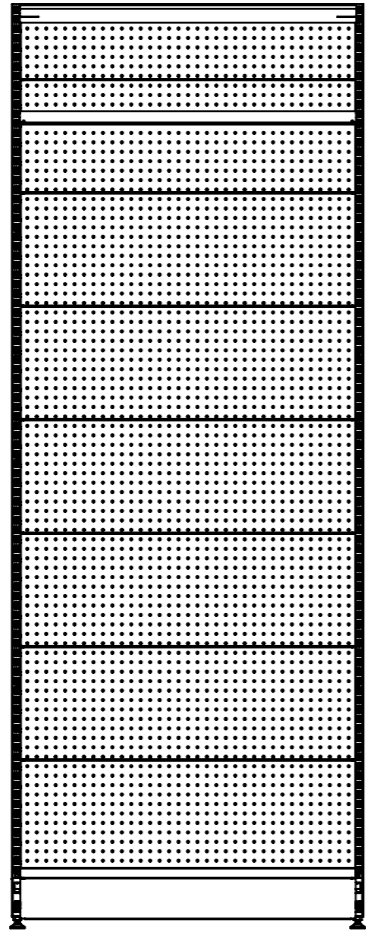
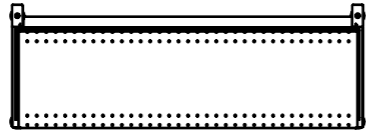
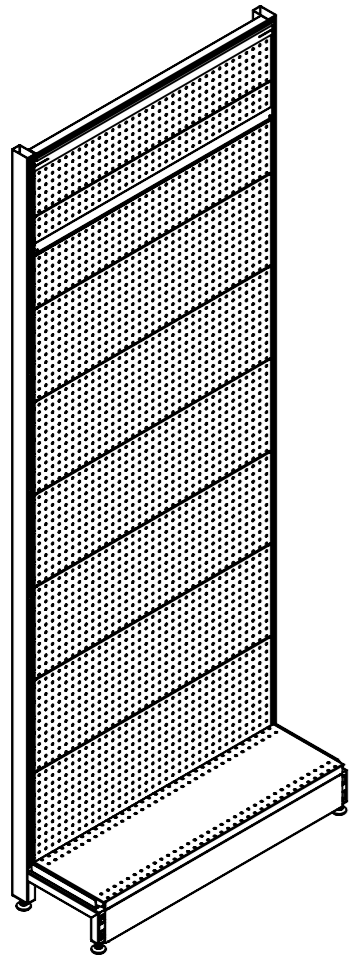

AP ASSOCIATED PROJECTS COMMERCIAL BUILDERS, PROJECT MANAGERS, PLANNERS & DESIGNERS

T 03 8787 3000 F 03 8787 3025
48-58 Cyber Loop, Dandenong South VIC 3175

Rev	Date	Description

ALL DIMENSIONS IN (mm)
UNLESS OTHERWISE SPECIFIED
BREAK ALL SHARP EDGES

TOLERANCES
(BEFORE PAINTING
& AFTER PLATING)
X ± 1.00
X.X ± 0.50
X.XX ± 0.10
ANGLES ± 0.5°

A04- EXPLODED
CLIENT: RFA
PROJ. NO.: TBA
PART NO.: --
Revision --
Page 4

900mm (W) x 2415mm (H) x 270mm (D)
WALL BAY - PERFORATED
START BAY

PRODUCT CODE: **RFA1004/RFA1061**

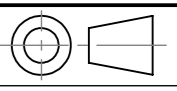
Date:	28/10/2022	 DO NOT SCALE
Drawn by	CB	
Checked by	--	

Scale@A3 1:20