

This product is an Add Bay  
 \* Supplied with (1) post Only  
 \* Connects to the post of the neighboring Bay

Rev	Date	Description

ALL DIMENSIONS IN (mm)  
 UNLESS OTHERWISE SPECIFIED  
 BREAK ALL SHARP EDGES

TOLERANCES  
 (BEFORE PAINTING  
 & AFTER PLATING)  
 X ± 1.00  
 X.X ± 0.50  
 X.XX ± 0.10  
 ANGLES ± 0.5°

A02- RENDER

CLIENT: RFA

PROJ. NO.: TBA

PART NO.: --

Revision --

Page 2

600mm (W) x 2415mm (H) x 270mm (D)  
 WALL BAY PERFORATED W/ SKIRT DRAWER  
 ADD BAY (MATTE BLACK)

PRODUCT CODE: **RFA1060**

Date: 28/10/2022

Drawn by CB

Checked by --

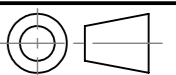

DO NOT SCALE

Scale@A3 1:1

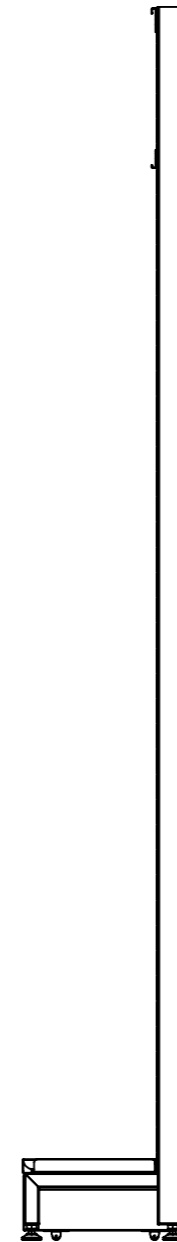
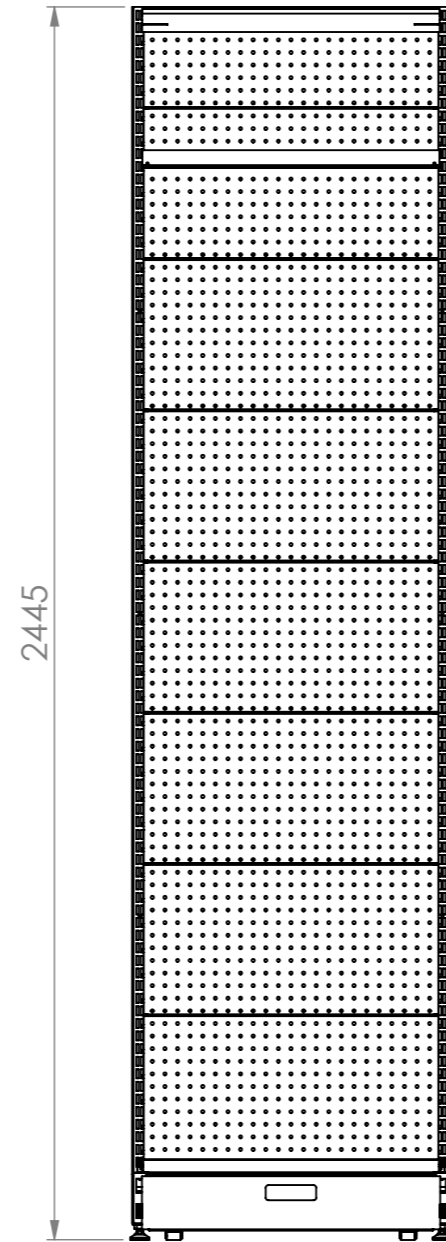
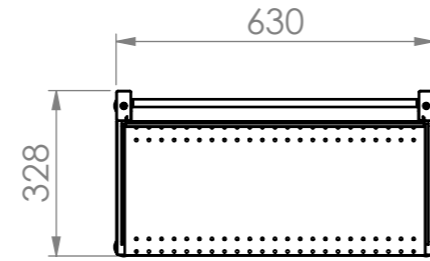
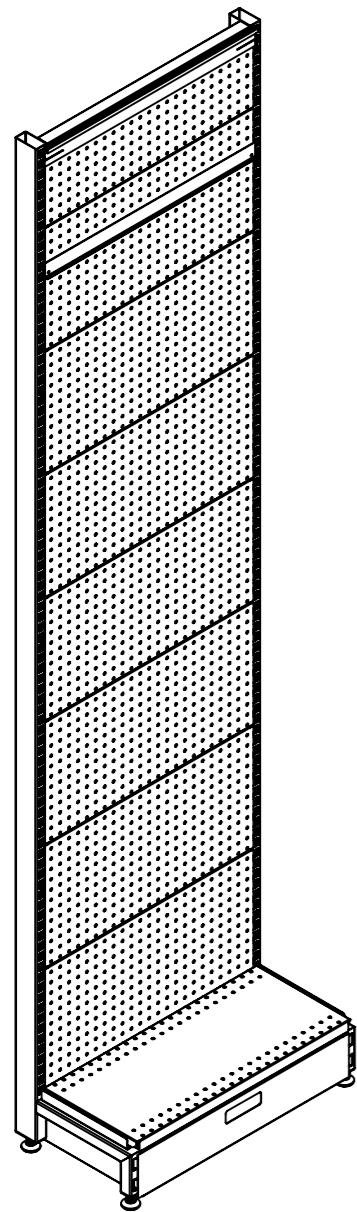

Rev	Date	Description

ALL DIMENSIONS IN (mm)  
UNLESS OTHERWISE SPECIFIED  
BREAK ALL SHARP EDGES

TOLERANCES  
(BEFORE PAINTING  
& AFTER PLATING)  
X ± 1.00  
X.X ± 0.50  
X.XX ± 0.10  
ANGLES ± 0.5°

**A03- DIMENSIONS**

CLIENT: RFA  
PROJ. NO.: TBA  
PART NO.: --  
Revision --  
Page 3

600mm (W) x 2415mm (H) x 270mm (D)  
WALL BAY - PERFORATED W/ SKIRT DRAWER  
ADD BAY

PRODUCT CODE: /RFA1060

Date: 28/10/2022

Drawn by CB

Checked by --

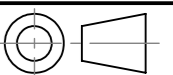

DO NOT SCALE

Scale@A3 1:15

ITEM NO.	SW-File Name(File Name)	QTY.
1	RFA1100 2400mm (H) WALL BAY POST	2
2	RFA1321-RFA1322 600X270 STEEL SHELF	1
3	RFA1101-RFA1201 600X300 PERF PANEL	7
4	RFA1103-RFA1203 600X200 PERF PANEL	1
5	RFA1116 600mm (W) SIGNAGE TOP BRACKET	1
6	RFA1117 600mm (W) SIGNAGE BOTTOM BRACKET	1
7	AP1000 DRAWER SKIRT Assy	1

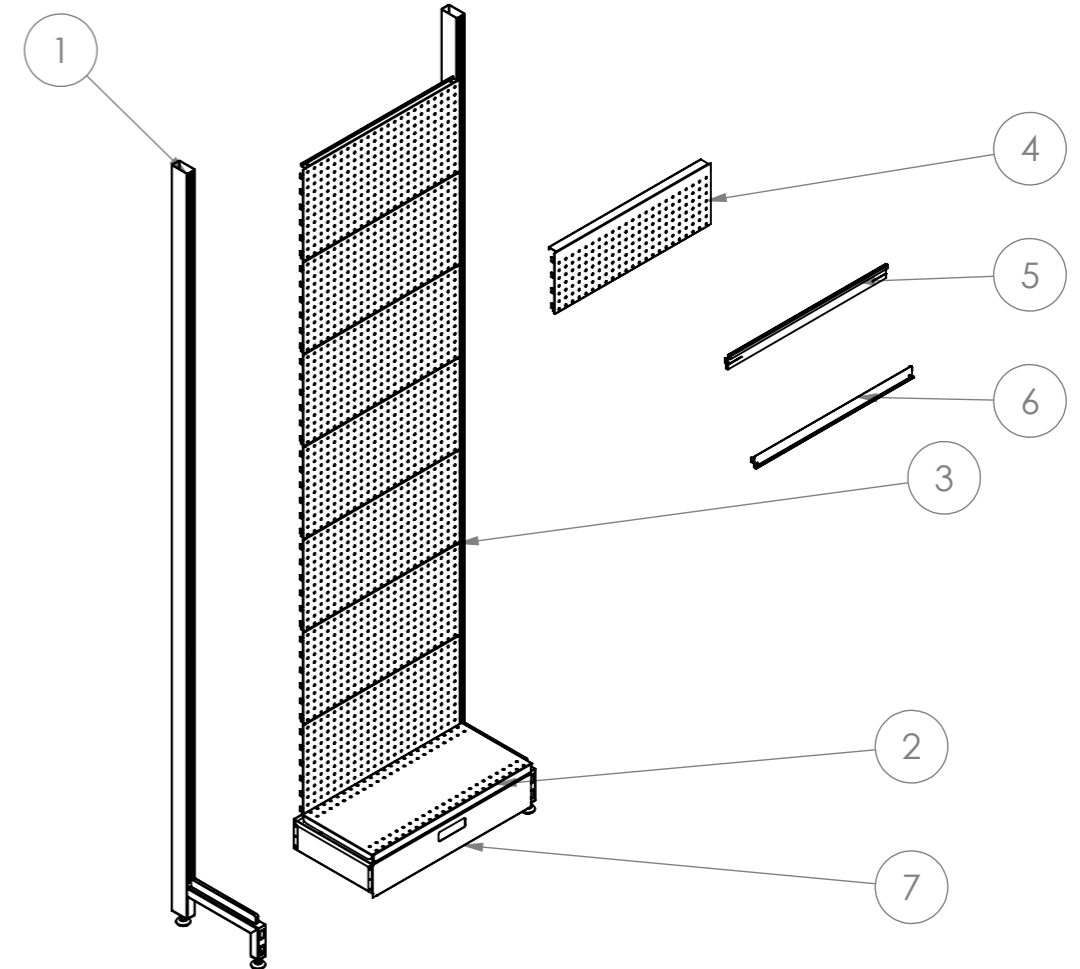
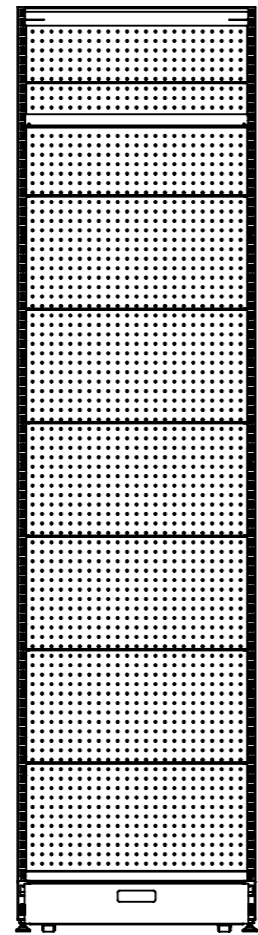
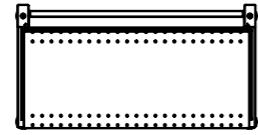
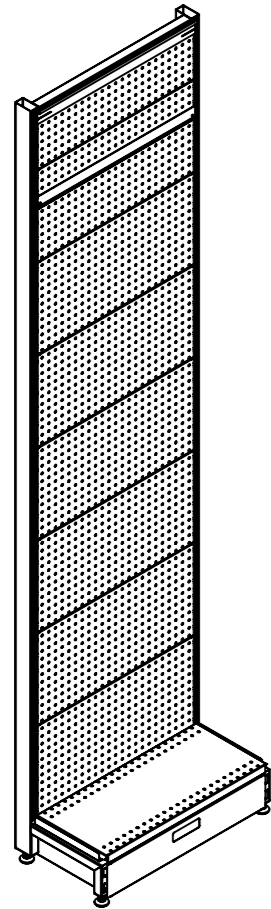

Rev	Date	Description

ALL DIMENSIONS IN (mm)  
UNLESS OTHERWISE SPECIFIED  
BREAK ALL SHARP EDGES

TOLERANCES  
(BEFORE PAINTING  
& AFTER PLATING)  
X ± 1.00  
X.X ± 0.50  
X.XX ± 0.10  
ANGLES ± 0.5°

A04- EXPLODED

CLIENT: RFA  
PROJ. NO.: TBA  
PART NO.: --  
Revision --  
Page 4

600mm (W) x 2415mm (H) x 270mm (D)  
WALL BAY - PERFORATED W/ SKIRT DRAWER  
ADD BAY

PRODUCT CODE: **RFA1060**

Date: 28/10/2022

Drawn by CB

Checked by --

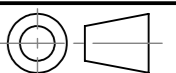

DO NOT SCALE

Scale@A3 1:20