

This product is an Add Bay
 * Supplied with (1) post only
 * Connects the the post of the
 Neighboring Bay

Rev	Date	Description

ALL DIMENSIONS IN (mm)
 UNLESS OTHERWISE SPECIFIED
 BREAK ALL SHARP EDGES

TOLERANCES
 (BEFORE PAINTING
 & AFTER PLATING)
 X ± 1.00
 X.X ± 0.50
 X.XX ± 0.10
 ANGLES ± 0.5°

A01-RENDER

CLIENT: RFA
 PROJ. NO.: TBA
 PART NO.: --
 Revision --
 Page 2

600mm (W) x 2415mm (H) x 270mm (D)
 WALL BAY - PERFORATED
 ADD BAY (MATTE BLACK)

PRODUCT CODE: **RFA1058**
 Date: 28/10/2022
 Drawn by -
 Checked by --

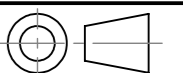

DO NOT SCALE
 Scale@A3 1:1

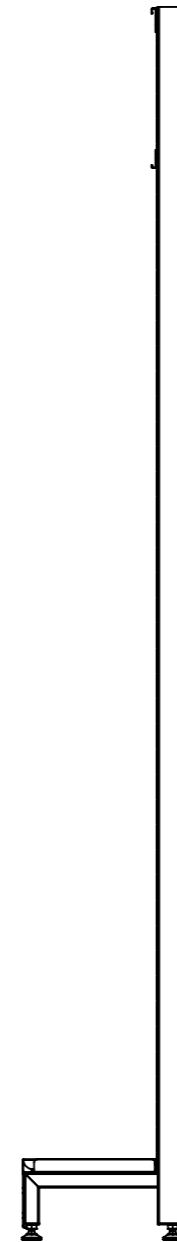
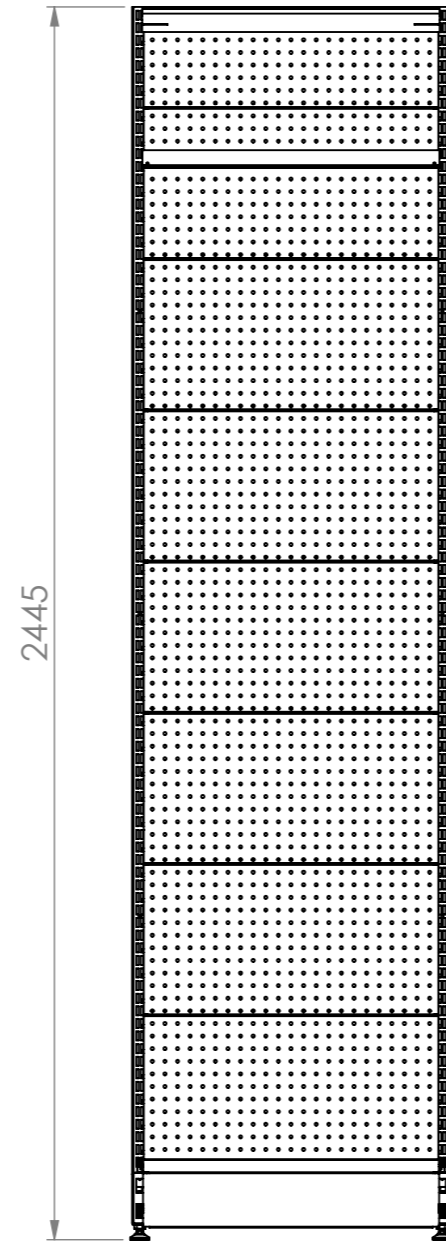
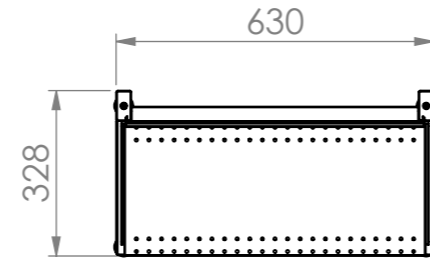
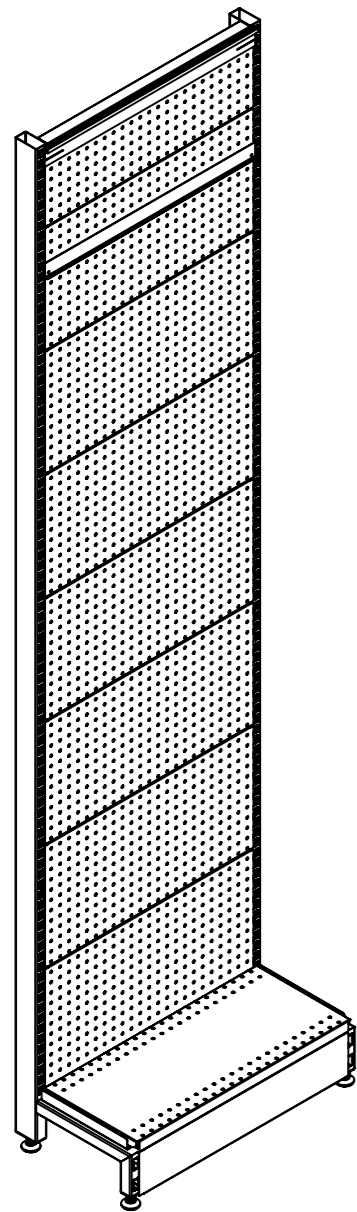

Rev	Date	Description

ALL DIMENSIONS IN (mm)
UNLESS OTHERWISE SPECIFIED
BREAK ALL SHARP EDGES

TOLERANCES
(BEFORE PAINTING
& AFTER PLATING)
X ± 1.00
X.X ± 0.50
X.XX ± 0.10
ANGLES ± 0.5°

A03-DIMENSIONS

CLIENT: RFA
PROJ. NO.: TBA
PART NO.: --
Revision --
Page 3

600mm (W) x 2415mm (H) x 270mm (D)
WALL BAY - PERFORATED
ADD BAY

PRODUCT CODE: RFA1058	
Date:	28/10/2022
Drawn by	-
Checked by	--

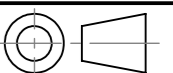

DO NOT SCALE

Scale@A3 1:15

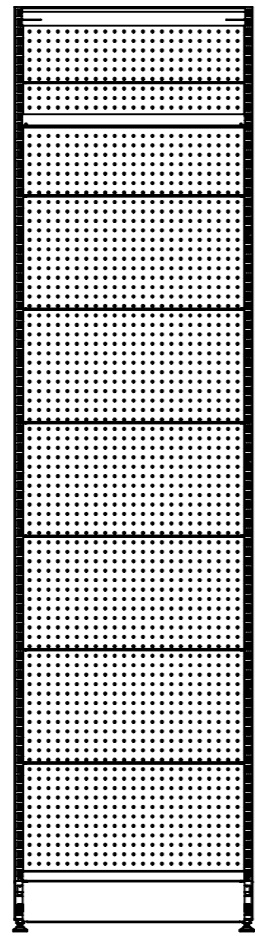
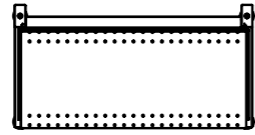
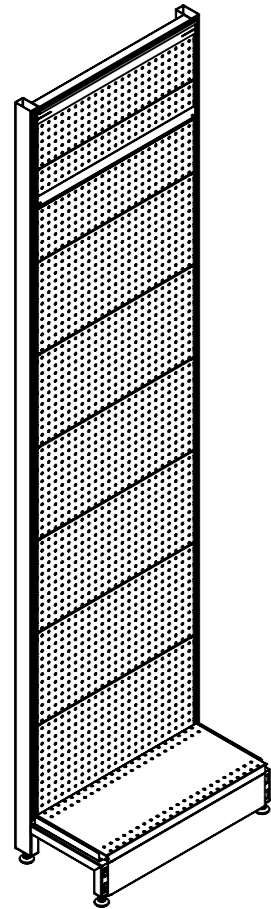

ITEM NO.	PART NUMBER	QTY.
1	RFA1100 2400mm (H) WALL BAY POST	2
2	RFA1321-RFA1322 600X270 STEEL SHELF	1
3	RFA1101-RFA1201 600X300 NON PERF PANEL	7
4	RFA1103-RFA1203 600X200 NON PERF PANEL	1
5	RFA1117 600mm (W) SIGNAGE BOTTOM BRACKET	1
6	RFA1116 600mm (W) SIGNAGE TOP BRACKET	1
7	RFA1109-RFA1209 SKIRT	1

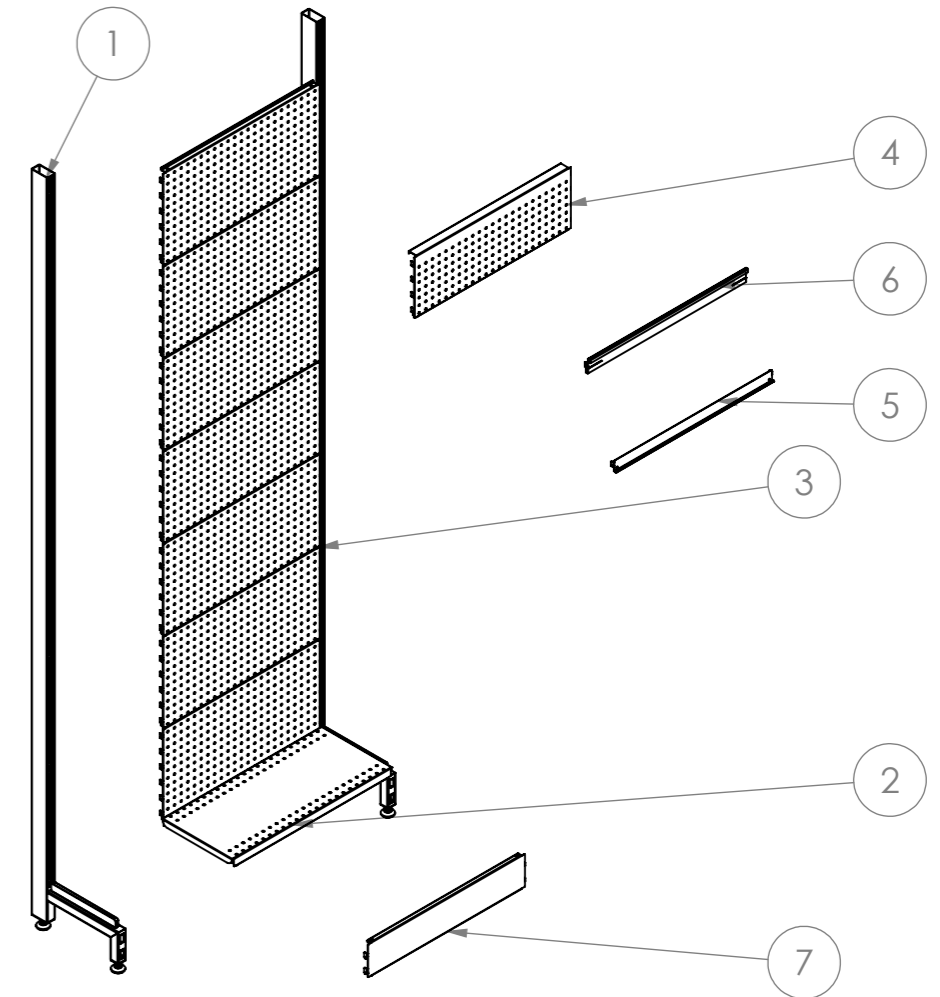

Rev	Date	Description

ALL DIMENSIONS IN (mm)
UNLESS OTHERWISE SPECIFIED
BREAK ALL SHARP EDGES

TOLERANCES
(BEFORE PAINTING
& AFTER PLATING)
X ± 1.00
X.X ± 0.50
X.XX ± 0.10
ANGLES ± 0.5°

A04-EXPLODED

CLIENT: RFA
PROJ. NO.: TBA
PART NO.: --
Revision --
Page 4

600mm (W) x 2415mm (H) x 270mm (D)
WALL BAY - PERFORATED
ADD BAY

PRODUCT CODE: **RFA1058**

Date: 28/10/2022

Drawn by

Checked by

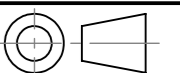

DO NOT SCALE

Scale@A3 1:20