

Rev	Date	Description

ALL DIMENSIONS IN (mm)  
UNLESS OTHERWISE SPECIFIED  
BREAK ALL SHARP EDGES

TOLERANCES  
(BEFORE PAINTING  
& AFTER PLATING)  
X ± 1.00  
X.X ± 0.50  
X.XX ± 0.10  
ANGLES ± 0.5°

**A01-RENDER**

CLIENT: RFA  
PROJ. NO.: TBA  
PART NO.: --  
Revision --  
Page 2

600mm (W) x 2415mm (H) x 270mm (D)  
WALL BAY - PERFORATED  
START BAY (MATTE BLACK)

PRODUCT CODE: **RFA1057**

Date: 28/10/2022

Drawn by -

Checked by --

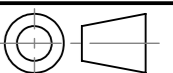

DO NOT SCALE

Scale@A3 1:1

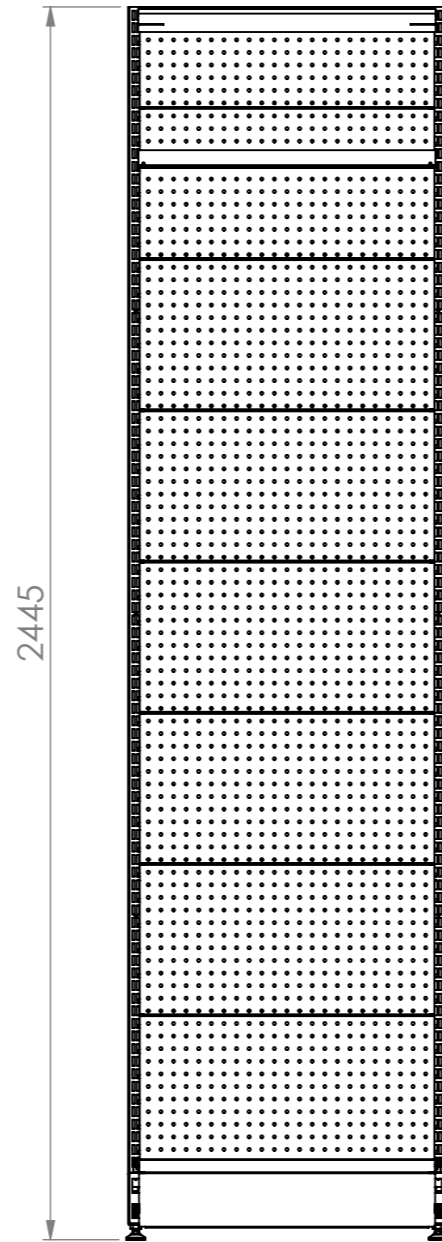
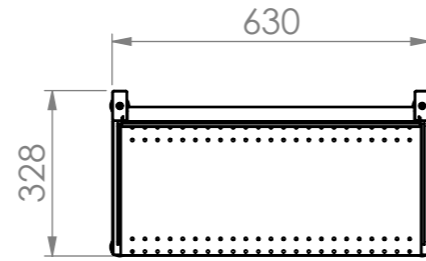
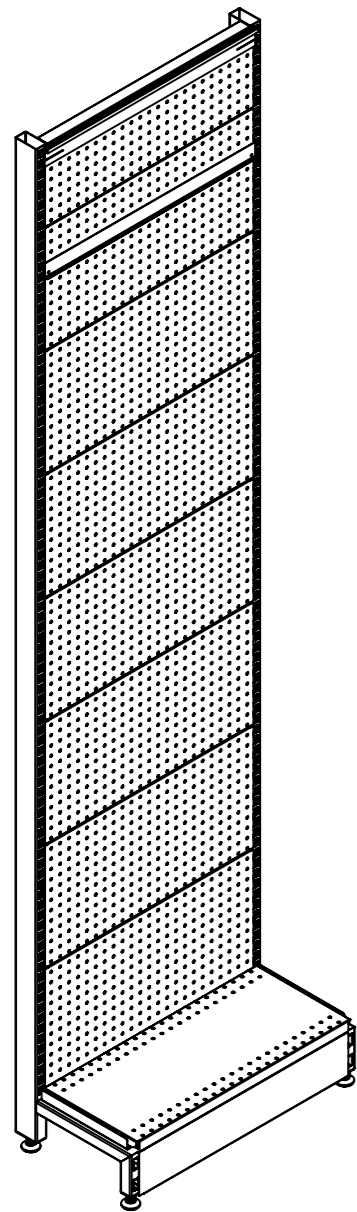

Rev	Date	Description

ALL DIMENSIONS IN (mm)  
UNLESS OTHERWISE SPECIFIED  
BREAK ALL SHARP EDGES

TOLERANCES  
(BEFORE PAINTING  
& AFTER PLATING)  
X ± 1.00  
X.X ± 0.50  
X.XX ± 0.10  
ANGLES ± 0.5°

**A03-DIMENSIONS**

CLIENT: RFA  
PROJ. NO.: TBA  
PART NO.: --  
Revision --  
Page 3

600mm (W) x 2415mm (H) x 270mm (D)  
WALL BAY - PERFORATED  
START BAY

PRODUCT CODE: **RFA1000/RFA1057**

Date: 28/10/2022

Drawn by -

Checked by --

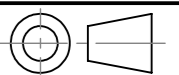

DO NOT SCALE

Scale@A3 1:15

ITEM NO.	PART NUMBER	QTY.
1	RFA1100 2400mm (H) WALL BAY POST	2
2	RFA1321-RFA1322 600X270 STEEL SHELF	1
3	RFA1101-RFA1201 600X300 PERF PANEL	7
4	RFA1103-RFA1203 600X200 PERF PANEL	1
5	RFA1117 600mm (W) SIGNAGE BOTTOM BRACKET	1
6	RFA1116 600mm (W) SIGNAGE TOP BRACKET	1
7	RFA1109-RFA1209 SKIRT	1

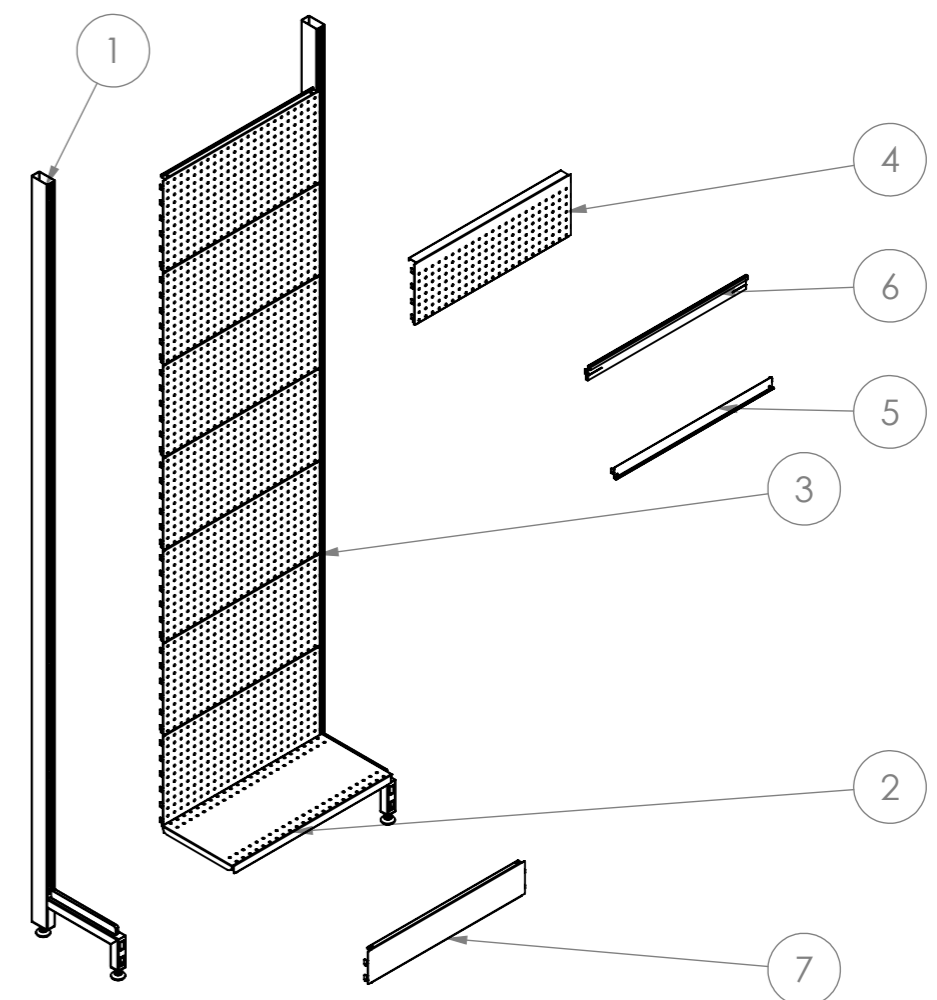
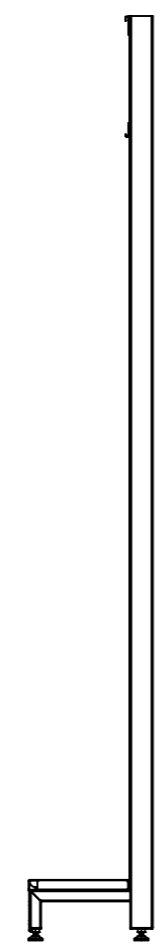
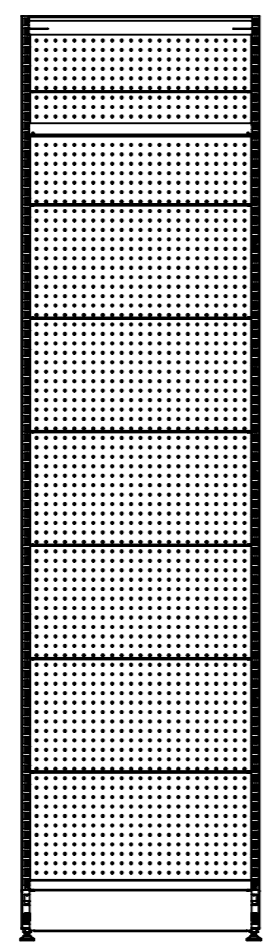
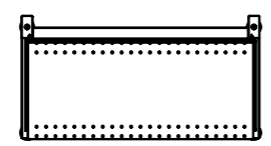
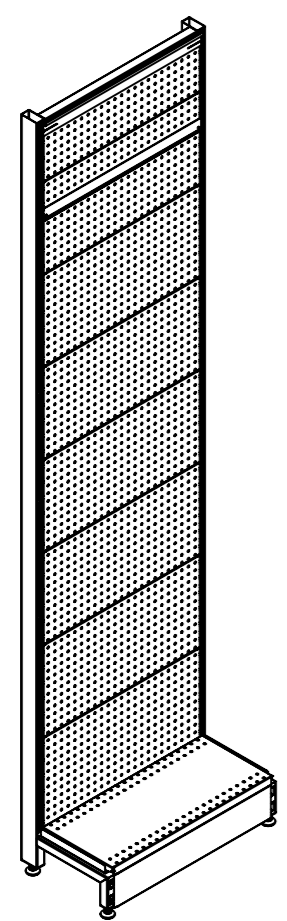

**AP ASSOCIATED PROJECTS** COMMERCIAL BUILDERS, PROJECT MANAGERS, PLANNERS & DESIGNERS

T 03 8787 3000 F 03 8787 3025  
48-58 Cyber Loop, Dandenong South VIC 3175

Rev	Date	Description

ALL DIMENSIONS IN (mm)  
UNLESS OTHERWISE SPECIFIED  
BREAK ALL SHARP EDGES

TOLERANCES  
(BEFORE PAINTING  
& AFTER PLATING)  
X ± 1.00  
X.X ± 0.50  
X.XX ± 0.10  
ANGLES ± 0.5°

**A04-EXPLODED**  
CLIENT: RFA  
PROJ. NO.: TBA  
PART NO.: --  
Revision --  
Page 4

600mm (W) x 2415mm (H) x 270mm (D)  
WALL BAY - PERFORATED  
START BAY

PRODUCT CODE: **RFA1000/RFA1057**

Date: 28/10/2022

Drawn by - DO NOT SCALE

Checked by -- Scale@A3 1:20