

This product is an Add Bay
 * Supplied with (1) post Only
 * Connects to the post of the Neighboring Bay

Rev	Date	Description

ALL DIMENSIONS IN (mm)
 UNLESS OTHERWISE SPECIFIED
 BREAK ALL SHARP EDGES

TOLERANCES
 (BEFORE PAINTING
 & AFTER PLATING)
 X ± 1.00
 X.X ± 0.50
 X.XX ± 0.10
 ANGLES ± 0.5°

A01- RENDER
 CLIENT: RFA1000
 PROJ. NO.: TBA
 PART NO.: --
 Revision --
 Page 1

RFA1016 600(W) X 1515 (H) DOUBLE SIDED GONDOLA BAY-PERFORATED - START BAY		
PRODUCT CODE: RFA1017	Date: 26/10/2022	
Drawn by: DH	Checked by: --	DO NOT SCALE
Scale@A3		1:20

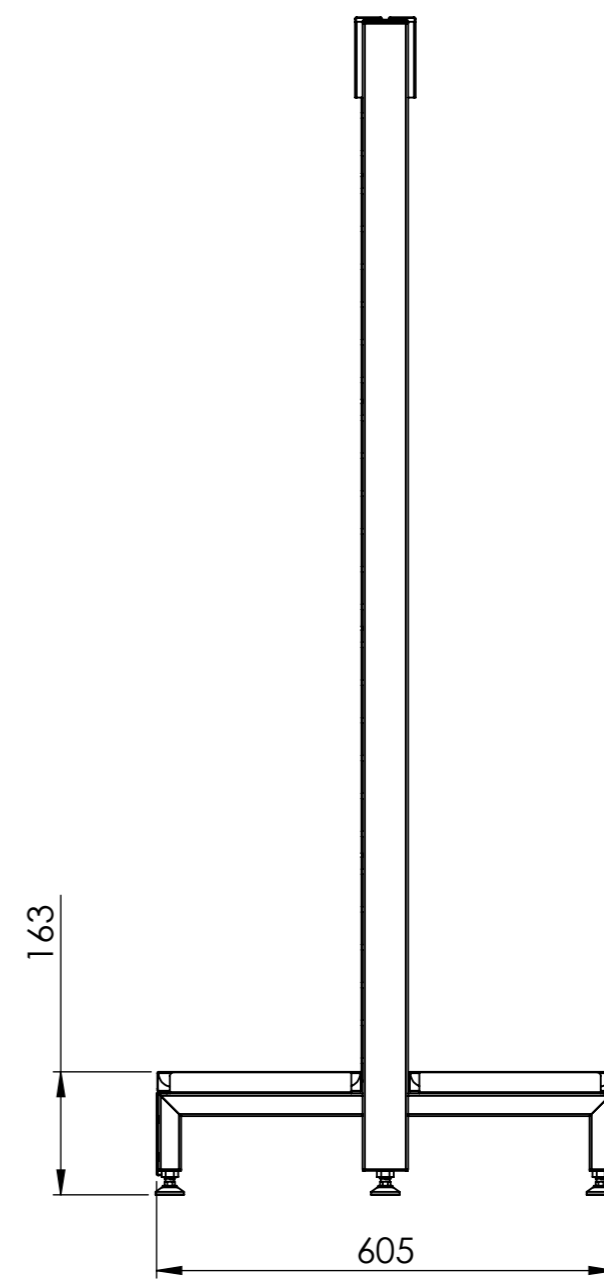
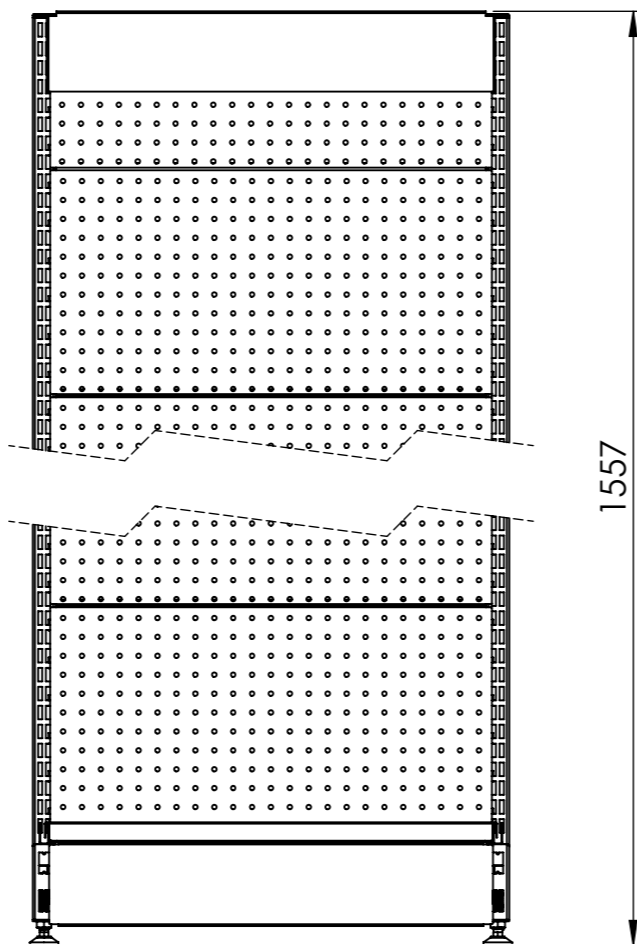
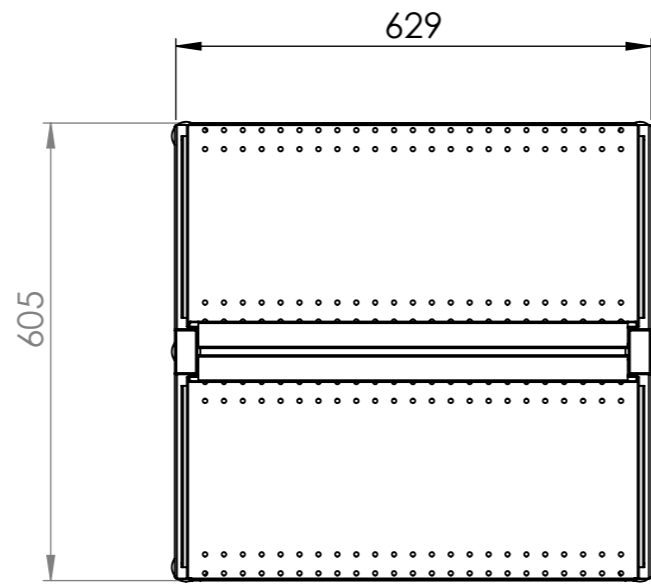
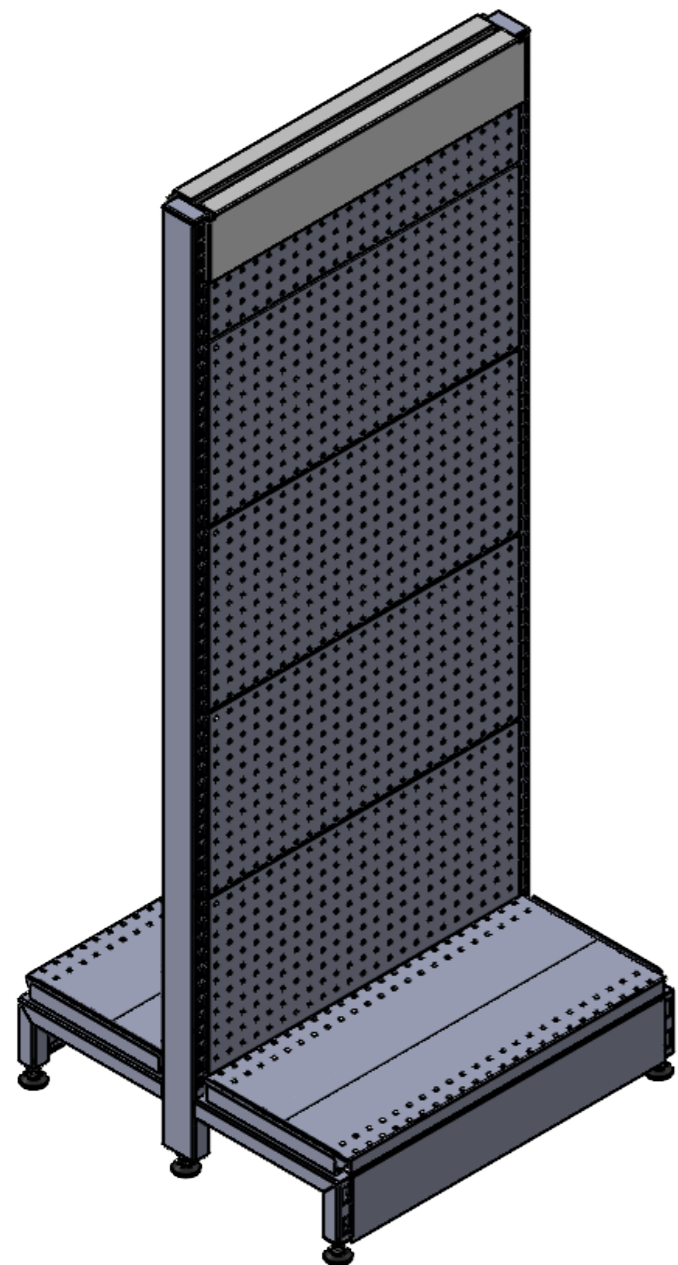

Rev	Date	Description

ALL DIMENSIONS IN (mm)
UNLESS OTHERWISE SPECIFIED
BREAK ALL SHARP EDGES

TOLERANCES
(BEFORE PAINTING
& AFTER PLATING)
X ± 1.00
X.X ± 0.50
X.XX ± 0.10
ANGLES ± 0.5°

A02- RENDER
CLIENT: RFA1000
PROJ. NO.: TBA
PART NO.: --
Revision --
Page 2

RFA1016 600(W) X 1515 (H) DOUBLE SIDED GONDOLA BAY-PERFORATED - START BAY

PRODUCT CODE: RFA1017

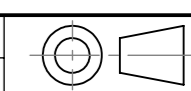
Date:	26/10/2022	 DO NOT SCALE
Drawn by	DH	
Checked by	--	

Scale@A3 1:15

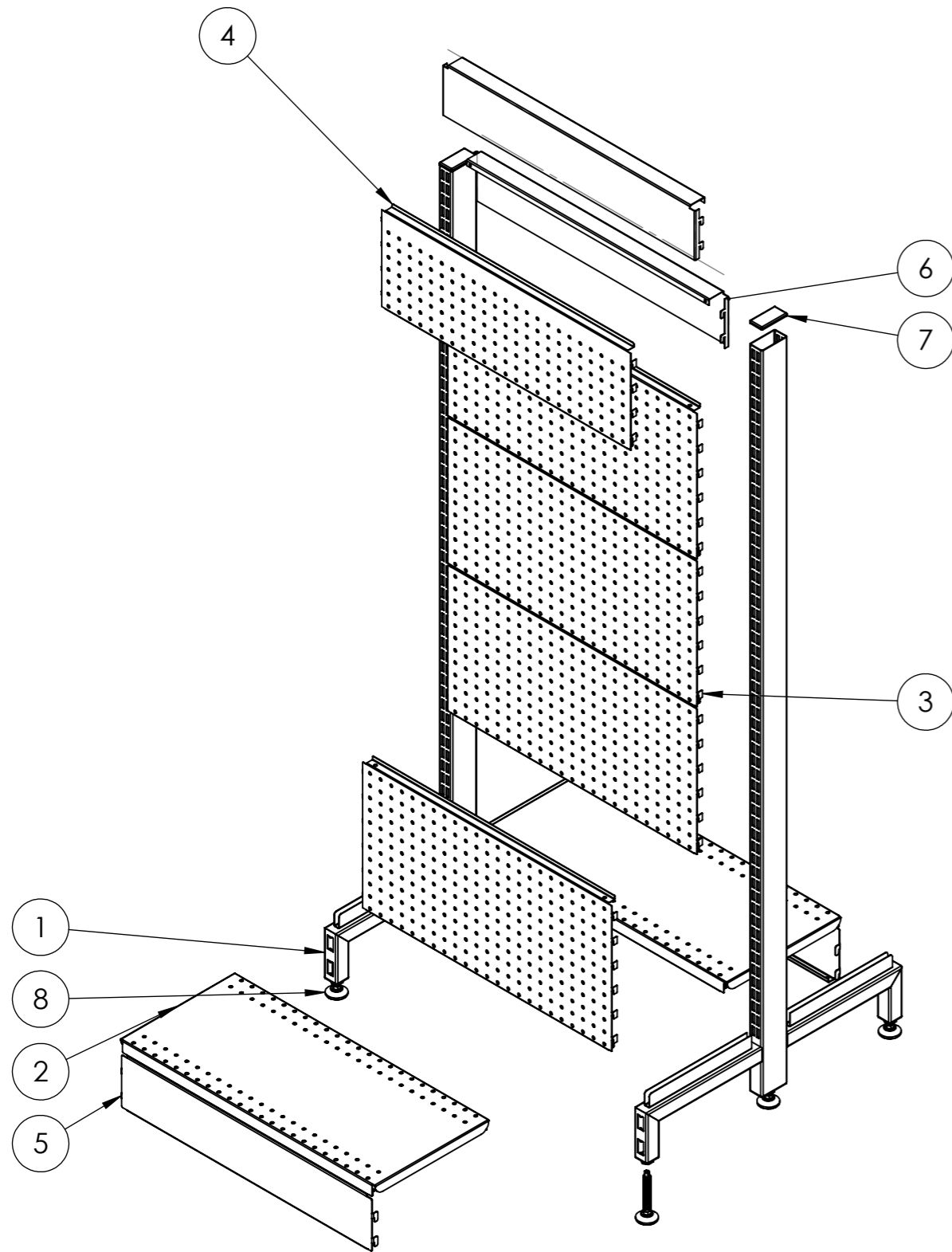

ITEM NO.	DESCRIPTION	QTY.
1	DOUBLE SIDED POST	2
2	600X270 SHELF	2
3	600W x 300H PERF PANEL	4
4	600W X 200H PERF. PANEL	1
5	BOTTOM SKIRT	2
6	SNAP IN TOP CAP	2
7	PLASTIC ENDCAP	2
8	ADJ. FEET	6

Rev	Date	Description

ALL DIMENSIONS IN (mm)
UNLESS OTHERWISE SPECIFIED
BREAK ALL SHARP EDGES

TOLERANCES
(BEFORE PAINTING
& AFTER PLATING)
X ± 1.00
X.X ± 0.50
X.XX ± 0.10
ANGLES ± 0.5°

A09- EXPLODED
CLIENT: RFA1000
PROJ. NO.: TBA
PART NO.: --
Revision --
Page 9

**RFA1016 600(W) X 1515 (H) DOUBLE
SIDED GONDOLA BAY-PERFORATED
- START BAY**

PRODUCT CODE: **RFA1017**

Date: 26/10/2022

Drawn by DH

Checked by --

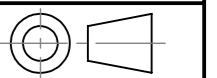

DO NOT SCALE

Scale@A3 1:20