

This Add Bay is only supplied with one post as it attaches to an existing post on a Start Bay.

Rev	Date	Description

ALL DIMENSIONS IN (mm)
UNLESS OTHERWISE SPECIFIED
BREAK ALL SHARP EDGES

TOLERANCES
(BEFORE PAINTING
& AFTER PLATING)
X ± 1.00
X.X ± 0.50
X.XX ± 0.10
ANGLES ± 0.5°

A01- RENDER
CLIENT: RFA
PROJ. NO.: TBA
PART NO.: --
Revision --
Page 1

600mm (W) x 2415mm (H) x 270mm (D)
WALL BAY - NON PERFORATED
START BAY (PEARL WHITE)

PRODUCT CODE: **RFA1008**

Date: 2/11/2022

Drawn by PS

Checked by --

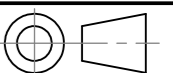

DO NOT SCALE

Scale@A3 1:1

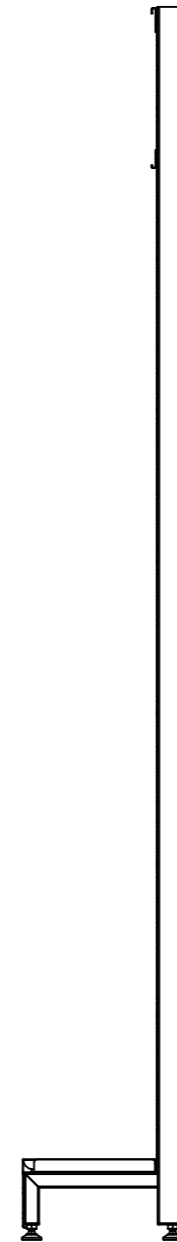
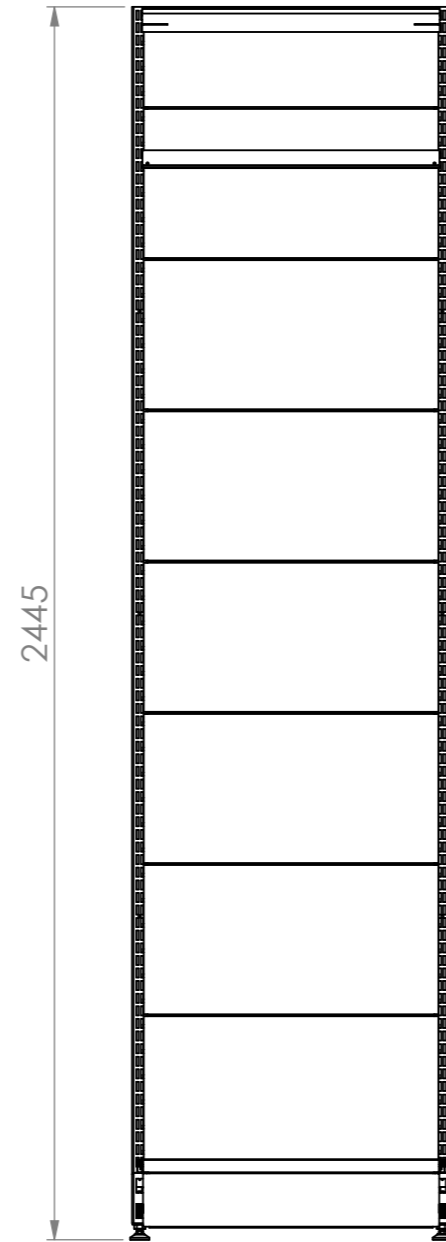
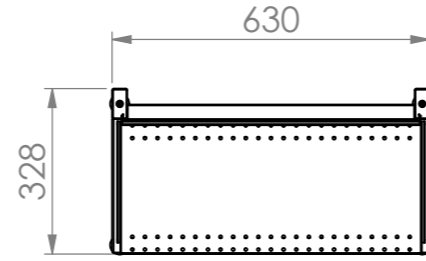
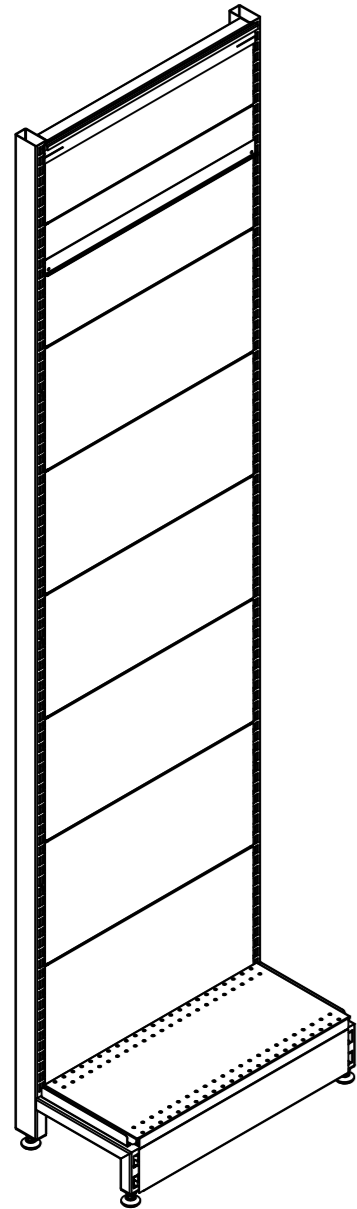

Rev	Date	Description

ALL DIMENSIONS IN (mm)
UNLESS OTHERWISE SPECIFIED
BREAK ALL SHARP EDGES

TOLERANCES
(BEFORE PAINTING
& AFTER PLATING)
X ± 1.00
X.X ± 0.50
X.XX ± 0.10
ANGLES ± 0.5°

A03- DIMENSIONS

CLIENT: RFA
PROJ. NO.: TBA
PART NO.: --
Revision --
Page 3

600mm (W) x 2415mm (H) x 270mm (D)
WALL BAY - NON PERFORATED
START BAY

PRODUCT CODE: **RFA1008/RFA1065**

Date: 28/10/2022

Drawn by PS

Checked by --

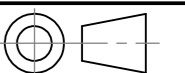

DO NOT SCALE

Scale@A3 1:15

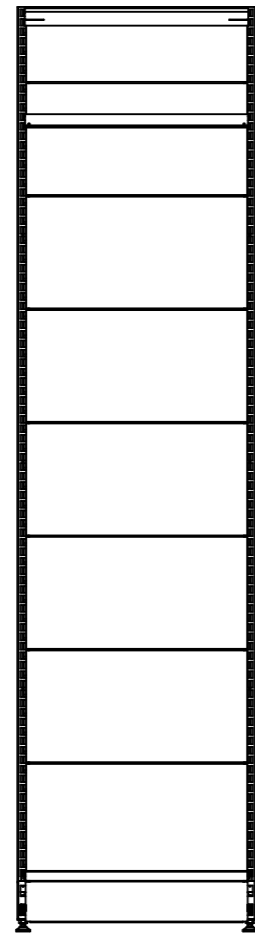
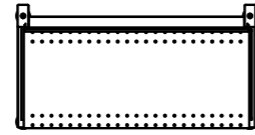
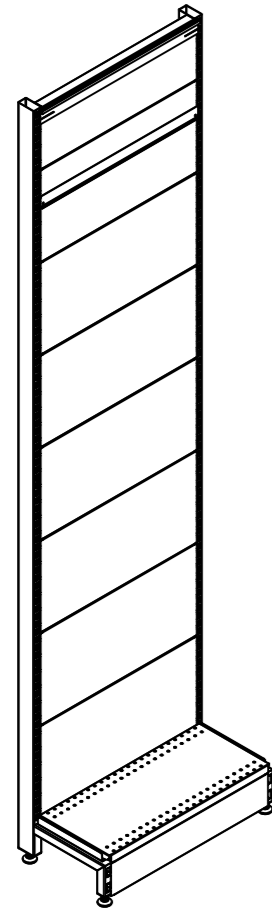

This Add Bay is only supplied with one post as it attaches to an existing post on a Start Bay.



ITEM NO.	PART NUMBER	QTY.
1	RFA1100 2400mm (H) WALL BAY POST	1
2	RFA1321-RFA1322 600X270 STEEL SHELF	1
3	RFA1101-RFA1201 600X300 PERF PANEL	7
4	RFA1103-RFA1203 600X200 PERF PANEL	1
5	RFA1109-RFA1209 SKIRT	1
6	RFA1117 600mm (W) SIGNAGE BOTTOM BRACKET	1
7	RFA1116 600mm (W) SIGNAGE TOP BRACKET	1

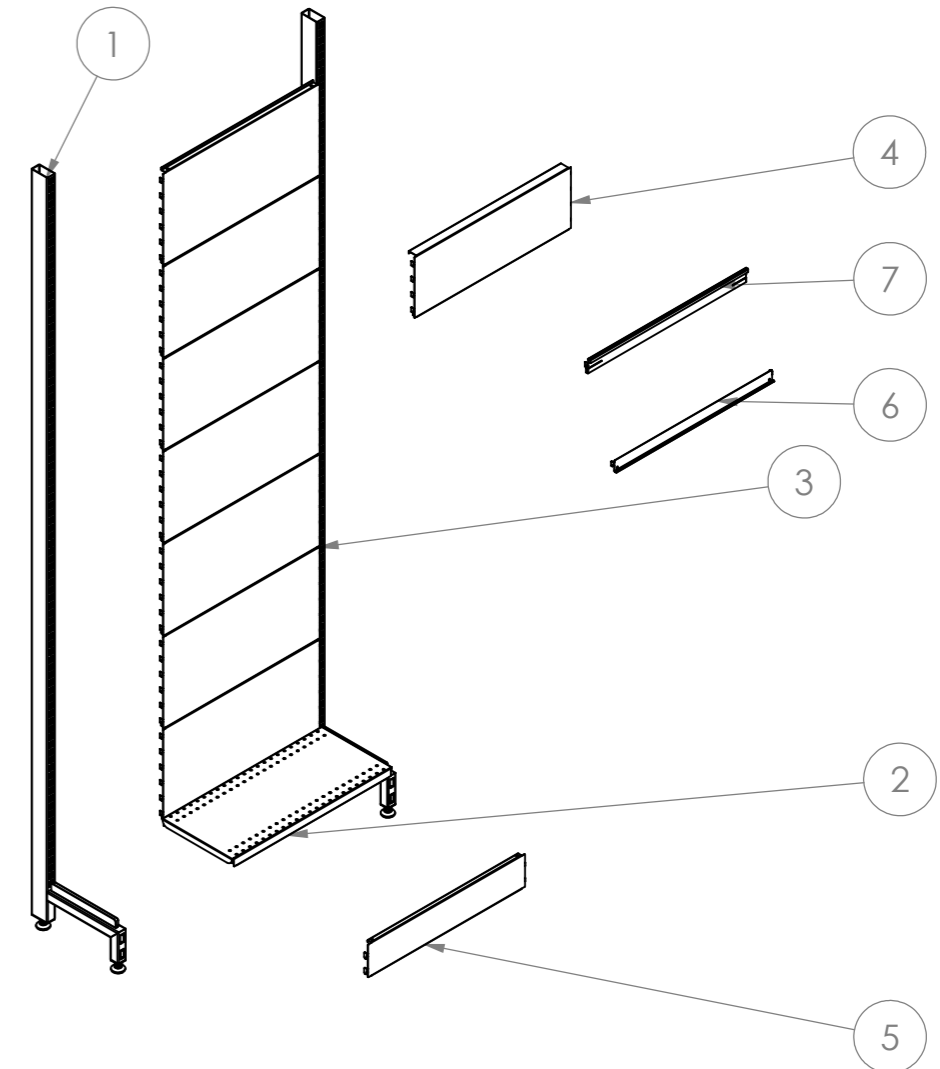

Rev	Date	Description

ALL DIMENSIONS IN (mm)
UNLESS OTHERWISE SPECIFIED
BREAK ALL SHARP EDGES

TOLERANCES
(BEFORE PAINTING
& AFTER PLATING)
X ± 1.00
X.X ± 0.50
X.XX ± 0.10
ANGLES ± 0.5°

A04- EXPLODED

CLIENT: RFA
PROJ. NO.: TBA
PART NO.: --
Revision --
Page 4

600mm (W) RFA WALL BAY

PRODUCT CODE: **RFA1008/RFA1065**

Date: 28/10/2022

Drawn by PS

Checked by --

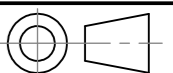

DO NOT SCALE

Scale@A3 1:20