

Rev	Date	Description

ALL DIMENSIONS IN (mm)  
UNLESS OTHERWISE SPECIFIED  
BREAK ALL SHARP EDGES

TOLERANCES  
(BEFORE PAINTING  
& AFTER PLATING)  
X ± 1.00  
X.X ± 0.50  
X.XX ± 0.10  
ANGLES ± 0.5°

**A01- RENDER**  
**CLIENT: RFA**  
**PROJ. NO.: TBA**  
**PART NO.: --**  
**Revision --**  
**Page 1**

**600mm (W) x 2415mm (H) x 270mm (D)**  
**WALL BAY - NON PERFORATED**  
**START BAY (PEARL WHITE)**

**PRODUCT CODE: RFA1008**

Date: 2/11/2022

Drawn by PS

Checked by --

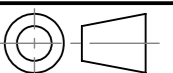

DO NOT SCALE

Scale@A3 1:1

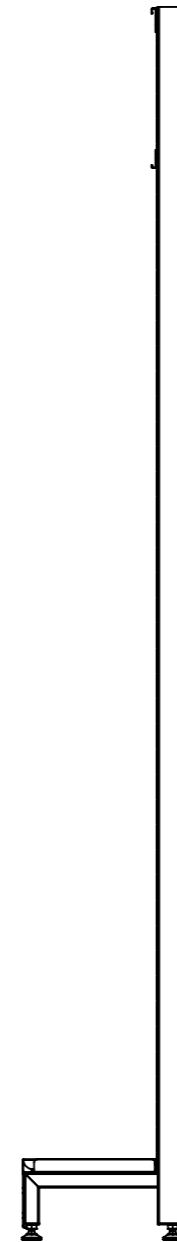
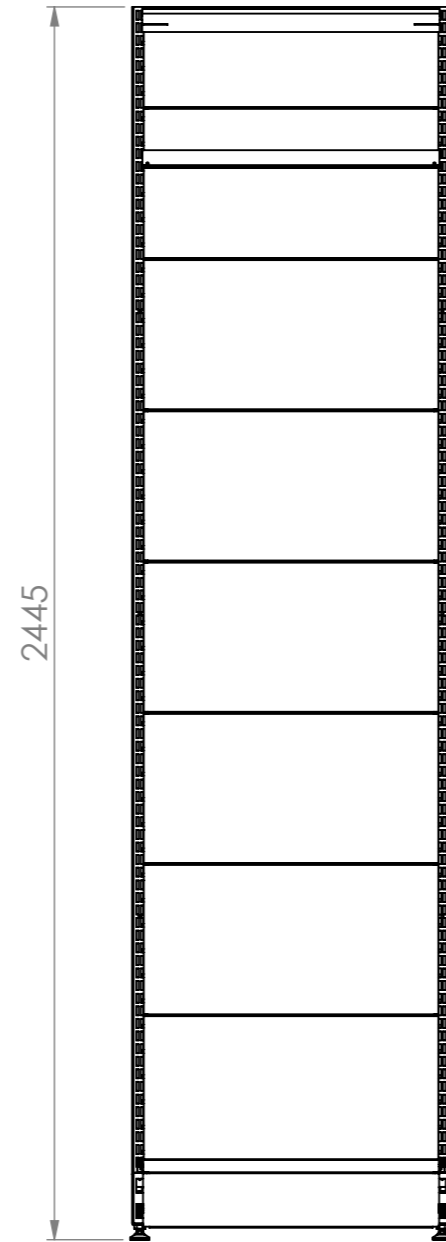
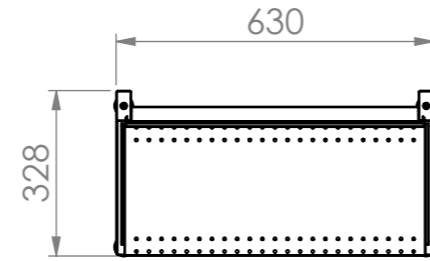
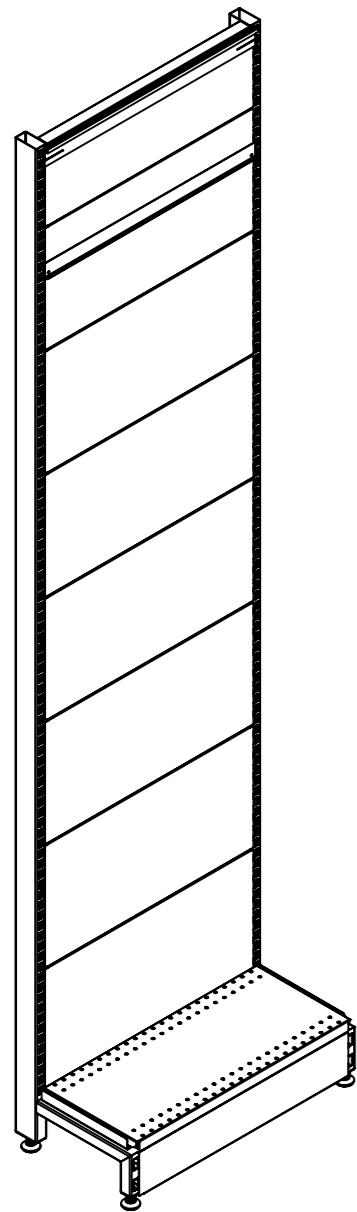

Rev	Date	Description

ALL DIMENSIONS IN (mm)  
UNLESS OTHERWISE SPECIFIED  
BREAK ALL SHARP EDGES

TOLERANCES  
(BEFORE PAINTING  
& AFTER PLATING)  
X ± 1.00  
X.X ± 0.50  
X.XX ± 0.10  
ANGLES ± 0.5°

**A03- DIMENSIONS**

CLIENT: RFA  
PROJ. NO.: TBA  
PART NO.: --  
Revision --  
Page 3

600mm (W) x 2415mm (H) x 270mm (D)  
WALL BAY - NON PERFORATED  
START BAY

PRODUCT CODE: **RFA1008/RFA1065**

Date: 28/10/2022

Drawn by PS

Checked by --

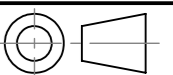

DO NOT SCALE

Scale@A3 1:15

ITEM NO.	PART NUMBER	QTY.
1	RFA1100 2400mm (H) WALL BAY POST	2
2	RFA1321-RFA1322 600X270 STEEL SHELF	1
3	RFA1101-RFA1201 600X300 PERF PANEL	7
4	RFA1103-RFA1203 600X200 PERF PANEL	1
5	RFA1109-RFA1209 SKIRT	1
6	RFA1117 600mm (W) SIGNAGE BOTTOM BRACKET	1
7	RFA1116 600mm (W) SIGNAGE TOP BRACKET	1

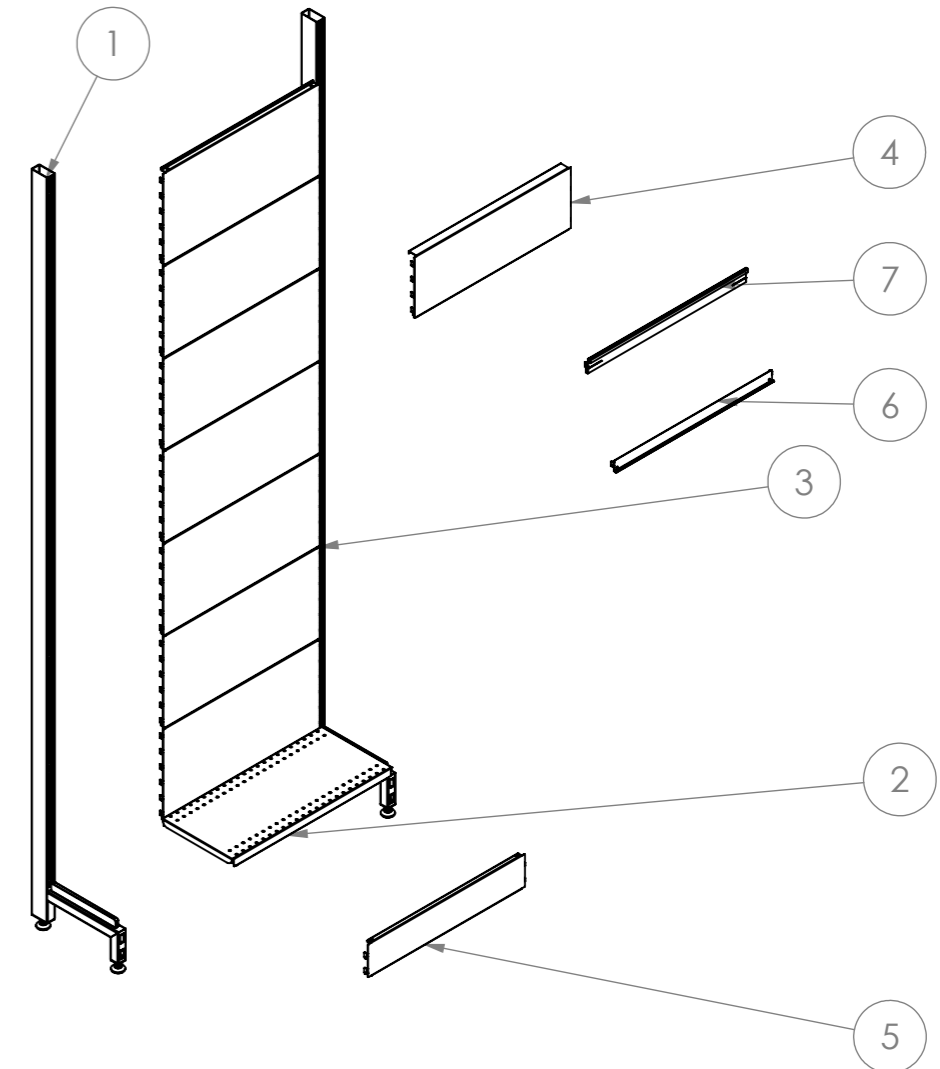
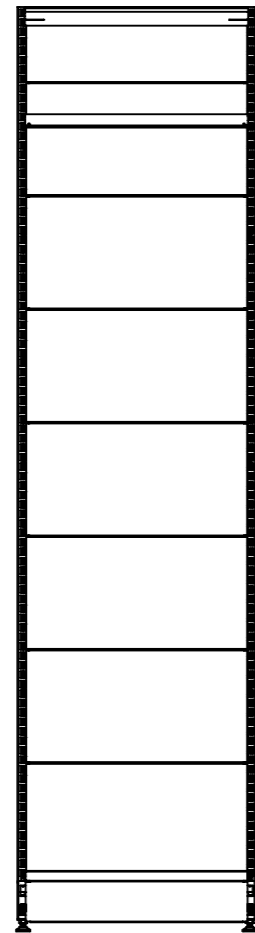
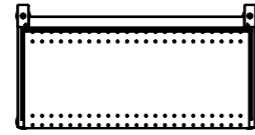
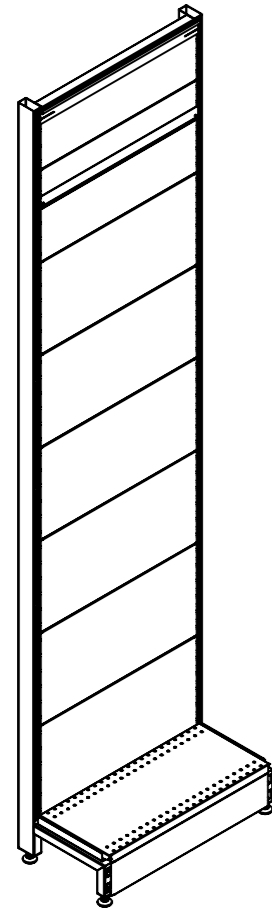

Rev	Date	Description

ALL DIMENSIONS IN (mm)  
UNLESS OTHERWISE SPECIFIED  
BREAK ALL SHARP EDGES

TOLERANCES  
(BEFORE PAINTING  
& AFTER PLATING)  
X ± 1.00  
X.X ± 0.50  
X.XX ± 0.10  
ANGLES ± 0.5°

A04- EXPLODED

CLIENT: RFA  
PROJ. NO.: TBA  
PART NO.: --  
Revision --  
Page 4

600mm (W) RFA WALL BAY

PRODUCT CODE: **RFA1008/RFA1065**

Date: 28/10/2022

Drawn by PS

Checked by --

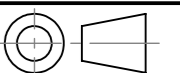

DO NOT SCALE

Scale@A3 1:20