

This Product is a Start Bay
 * Supplied with (1) Post Only
 * Add Bay connects to the post of the neighboring Bay

| Rev | Date | Description |
|-----|------|-------------|
| | | |
| | | |
| | | |
| | | |

ALL DIMENSIONS IN (mm)
 UNLESS OTHERWISE SPECIFIED
 BREAK ALL SHARP EDGES

TOLERANCES
 (BEFORE PAINTING
 & AFTER PLATING)
 X ± 1.00
 X.X ± 0.50
 X.XX ± 0.10
 ANGLES ± 0.5°

A01- RENDER
CLIENT: RFA
PROJ. NO.: TBA
PART NO.: --
Revision --
Page 1

| | | |
|--|-----------|--------------|
| 600mm (W) x 2415mm (H) x 270mm (D) WALL BAY - PERFORATED W/ SKIRT DRAWER START BAY (PEARL WHITE) | | |
| PRODUCT CODE: RFA1003 | | |
| Date: | 2/11/2022 | DO NOT SCALE |
| Drawn by | CB | |
| Checked by | -- | |
| Scale@A3 | | 1:1 |

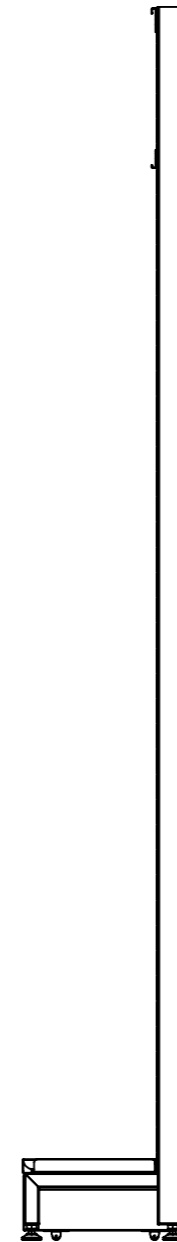
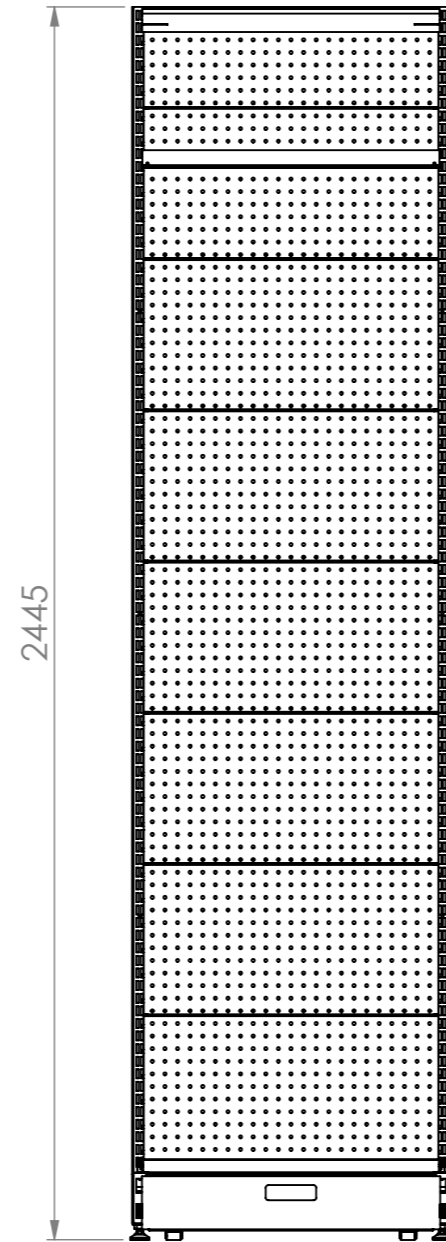
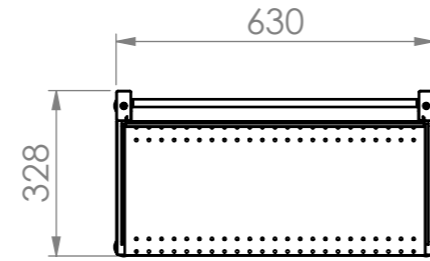
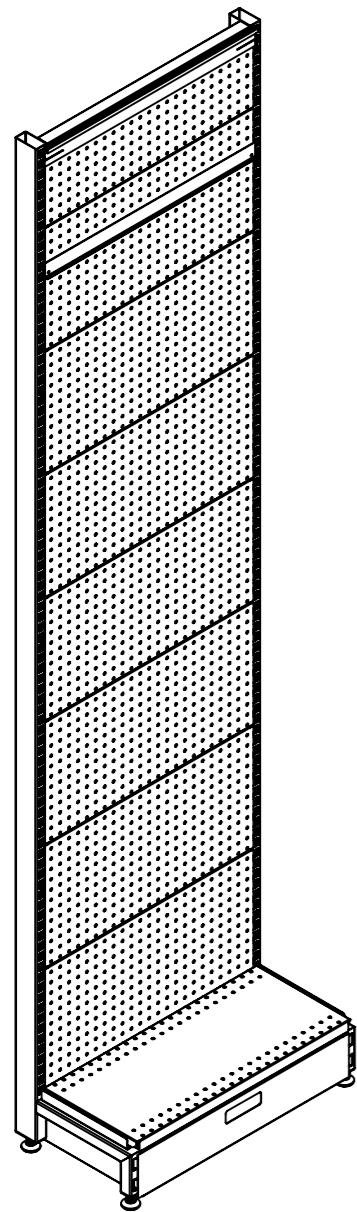

| Rev | Date | Description |
|-----|------|-------------|
| | | |
| | | |
| | | |

ALL DIMENSIONS IN (mm)
UNLESS OTHERWISE SPECIFIED
BREAK ALL SHARP EDGES

TOLERANCES
(BEFORE PAINTING
& AFTER PLATING)
X ± 1.00
X.X ± 0.50
X.XX ± 0.10
ANGLES ± 0.5°

A03- DIMENSIONS

CLIENT: RFA
PROJ. NO.: TBA
PART NO.: --
Revision --
Page 3

600mm (W) x 2415mm (H) x 270mm (D)
WALL BAY - PERFORATED W/ SKIRT DRAWER
START BAY

| | |
|------------------------------|------------|
| PRODUCT CODE: RFA1003 | |
| Date: | 28/10/2022 |
| Drawn by | CB |
| Checked by | -- |

DO NOT SCALE
Scale@A3 1:15

| ITEM NO. | SW-File Name(File Name) | QTY. |
|----------|--|------|
| 1 | RFA1100 2400mm (H) WALL BAY POST | 2 |
| 2 | RFA1321-RFA1322 600X270 STEEL SHELF | 1 |
| 3 | RFA1101-RFA1201 600X300 PERF PANEL | 7 |
| 4 | RFA1103-RFA1203 600X200 PERF PANEL | 1 |
| 5 | RFA1116 600mm (W) SIGNAGE TOP BRACKET | 1 |
| 6 | RFA1117 600mm (W) SIGNAGE BOTTOM BRACKET | 1 |
| 7 | AP1000 DRAWER SKIRT Assy | 1 |

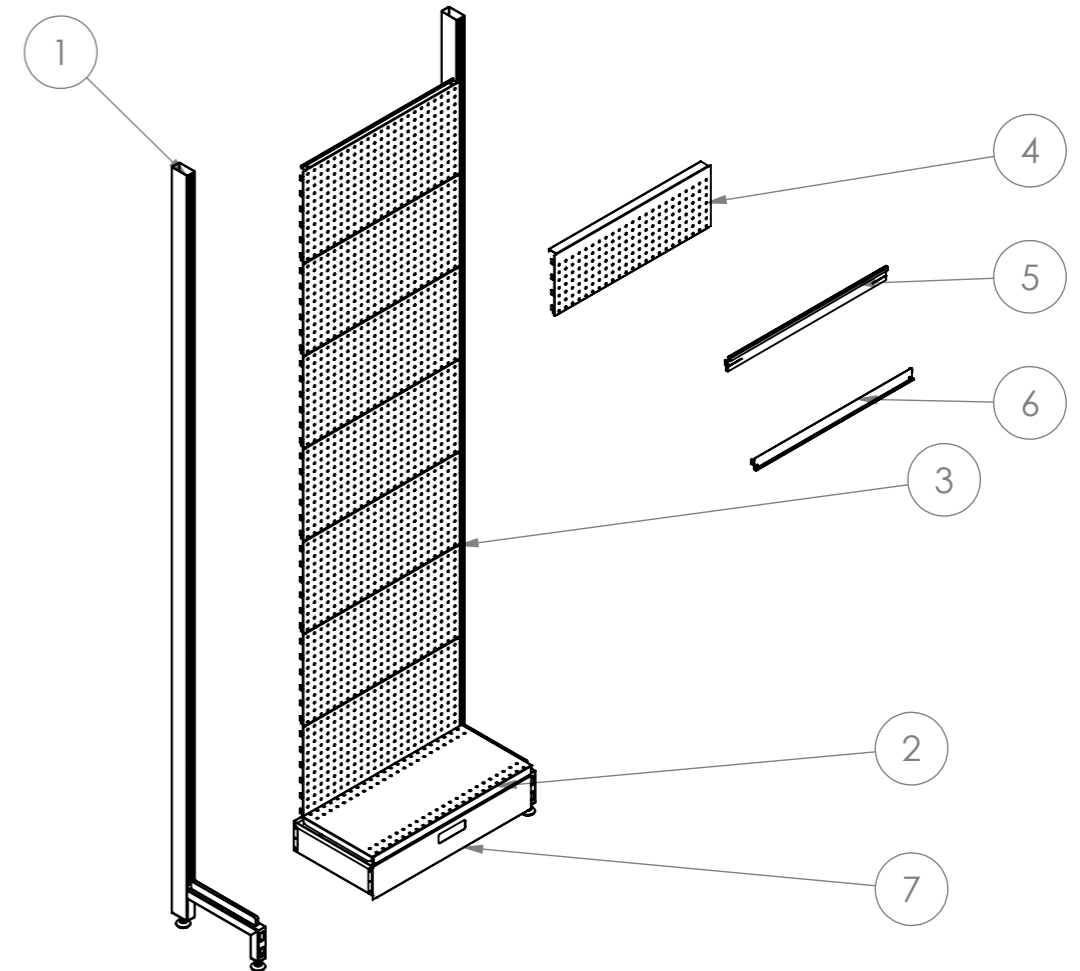
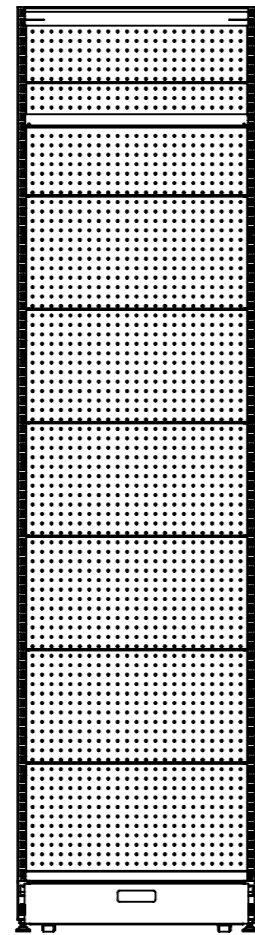
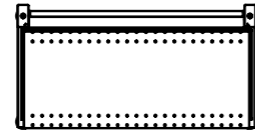
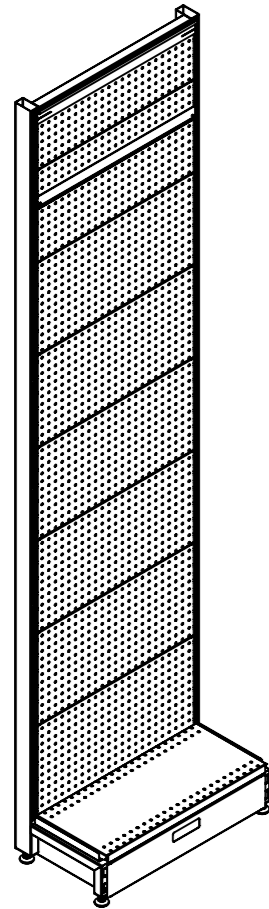

| Rev | Date | Description |
|-----|------|-------------|
| | | |
| | | |
| | | |

ALL DIMENSIONS IN (mm)
UNLESS OTHERWISE SPECIFIED
BREAK ALL SHARP EDGES

TOLERANCES
(BEFORE PAINTING
& AFTER PLATING)
X ± 1.00
X.X ± 0.50
X.XX ± 0.10
ANGLES ± 0.5°

A04- EXPLODED

CLIENT: RFA
PROJ. NO.: TBA
PART NO.: --
Revision --
Page 4

600mm (W) x 2415mm (H) x 270mm (D)
WALL BAY - PERFORATED W/ SKIRT DRAWER
START BAY

PRODUCT CODE: **RFA1003**

Date: 28/10/2022

Drawn by CB

Checked by --

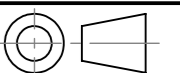

DO NOT SCALE

Scale@A3 1:20