



FINISH: P/C MATTE BLACK



T 03 8787 3000 F 03 8787 3025
48-58 Cyber Loop, Dandenong South
VIC 3175 (AUSTRALIA)

© COPYRIGHT. This drawing is the exclusive property of Associated Projects Pty Ltd. It is subject to protection and is strictly confidential. Reproduction in whole or in part is prohibited without obtaining prior permission in writing from the proprietor.

Rev	Date	Description

ALL DIMENSIONS IN (mm)
UNLESS OTHERWISE SPECIFIED
BREAK ALL SHARP EDGES

TOLERANCES
(BEFORE PAINTING
& AFTER PLATING)
X ± 1.00
X.X ± 0.50
X.XX ± 0.10
ANGLES ± 0.5°

A01- RENDER
CLIENT: -
PROJ. NO.: TBA
FINISH:-
MAT'L: Material <not specified>
Page 1

45 DEGREE CLOTHES HANGING ARM (FRONT HANG) - D300 - FOR HANG RAIL

PRODUCT CODE: **RFA0447**

Date: 1/11/2023

Drawn by DH

Checked by NP

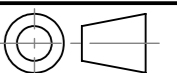

DO NOT SCALE

Scale@A3 1:1

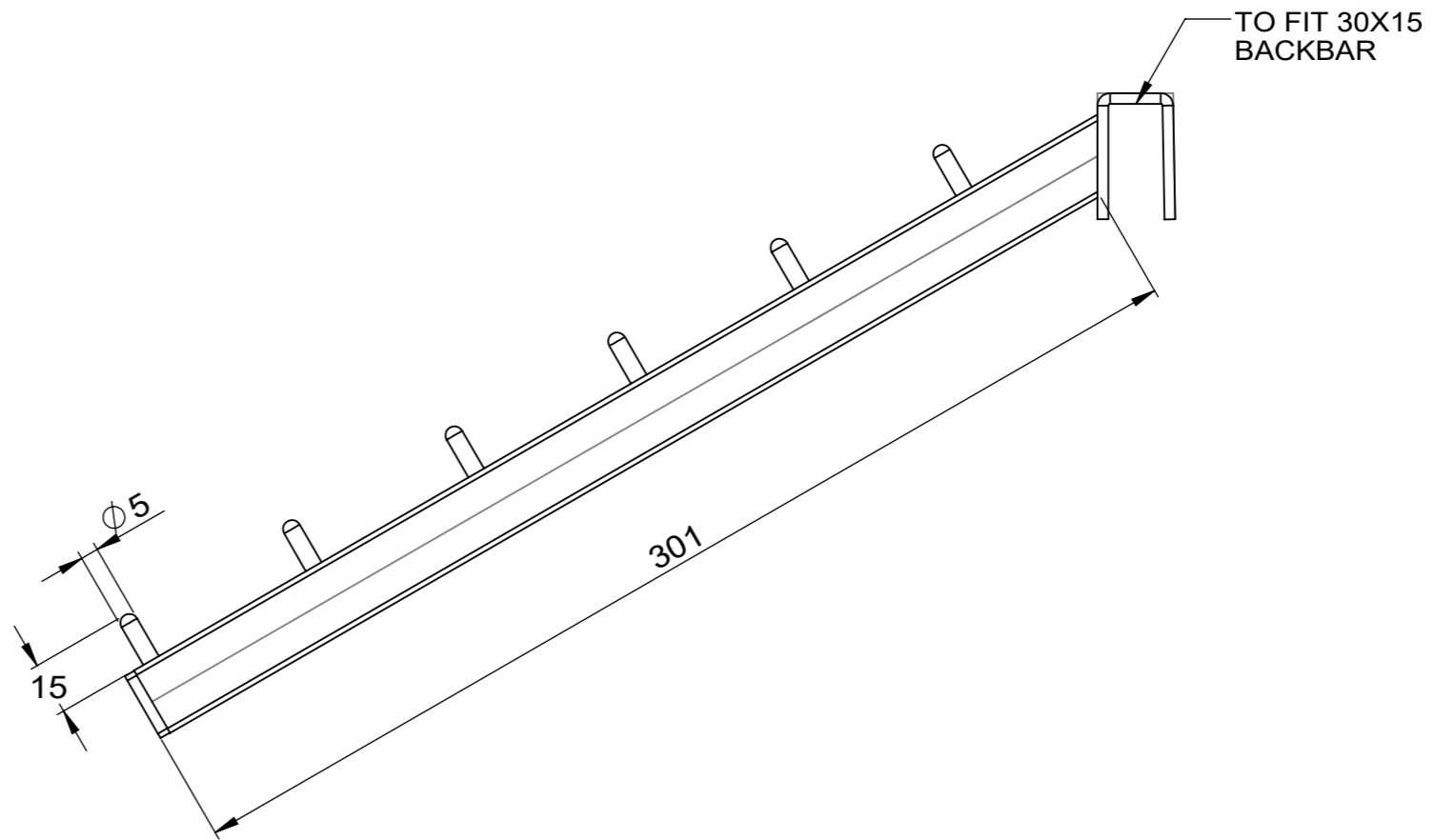
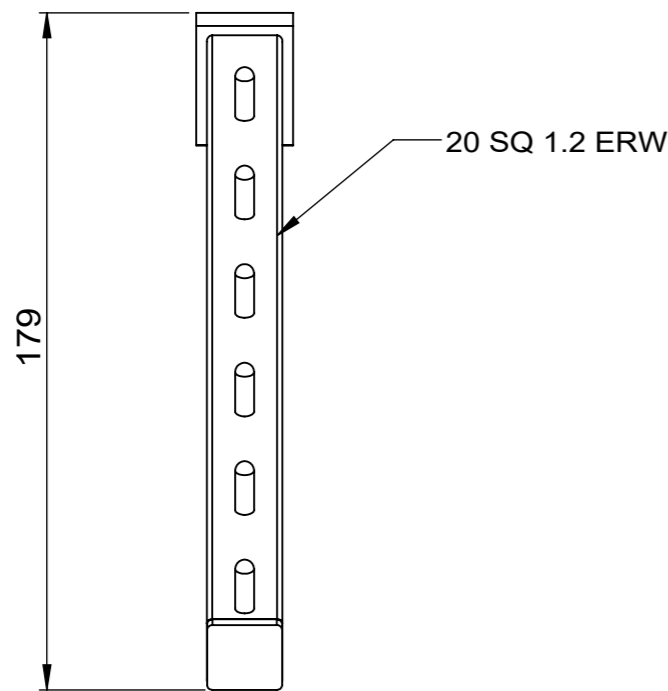
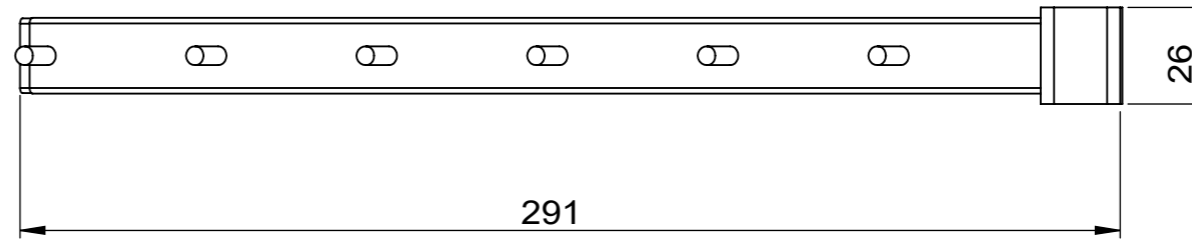
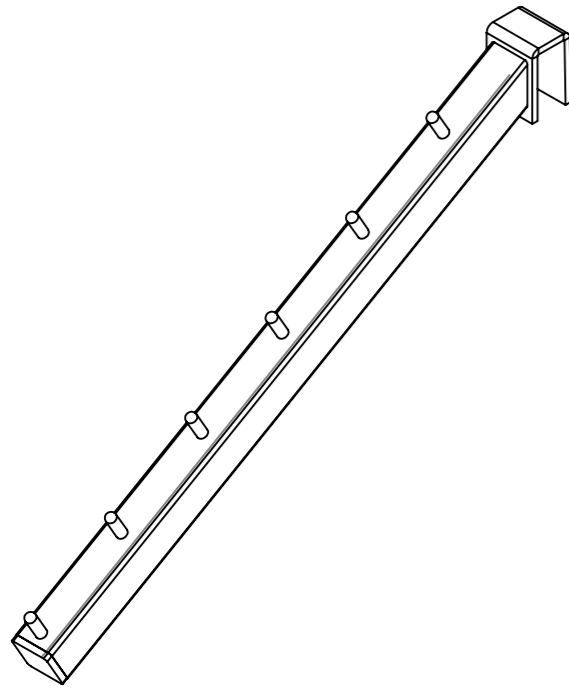

T 03 8787 3000 F 03 8787 3025
48-58 Cyber Loop, Dandenong South
VIC 3175 (AUSTRALIA)

© COPYRIGHT. This drawing is the exclusive property of Associated Projects Pty Ltd. It is subject to protection and is strictly confidential. Reproduction in whole or in part is prohibited without obtaining prior permission in writing from the proprietor.

Rev	Date	Description

ALL DIMENSIONS IN (mm)
UNLESS OTHERWISE SPECIFIED
BREAK ALL SHARP EDGES

TOLERANCES
(BEFORE PAINTING
& AFTER PLATING)
X ± 1.00
X.X ± 0.50
X.XX ± 0.10
ANGLES ± 0.5°

A02- CLIENT

CLIENT: -

PROJ. NO.: TBA

FINISH:-

MAT'L: Material <not specified>

Page 2

45 DEGREE CLOTHES HANGING ARM (FRONT HANG) - D300 - FOR HANG RAIL

PRODUCT CODE: **RFA0447**

Date: 1/11/2023

Drawn by DH

Checked by NP

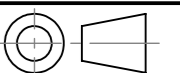

DO NOT SCALE

Scale@A3 1:2