

FINISH: P/C MATTE BLACK

AP ASSOCIATED PROJECTS COMMERCIAL BUILDERS,
PROJECT MANAGERS,
PLANNERS & DESIGNERS

T 03 8787 3000 F 03 8787 3025
48-58 Cyber Loop, Dandenong South VIC 3175

Rev	Date	Description

ALL DIMENSIONS IN (mm)
UNLESS OTHERWISE SPECIFIED
BREAK ALL SHARP EDGES

TOLERANCES
(BEFORE PAINTING
& AFTER PLATING)
X ± 1.00
X.X ± 0.50
X.XX ± 0.10
ANGLES ± 0.5°

A01- RENDER
CLIENT: JAKMAX
PROJ. NO.: TBA
PART NO.: --
Revision --
Page 1

900mm(W) x 200mm(H) x 450mm(D)
PELMET BOX
-

PRODUCT CODE: **RFA0251**

Date: 18/01/2024

Drawn by PS

Checked by --

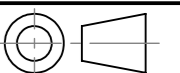

DO NOT SCALE

Scale@A3 1:10

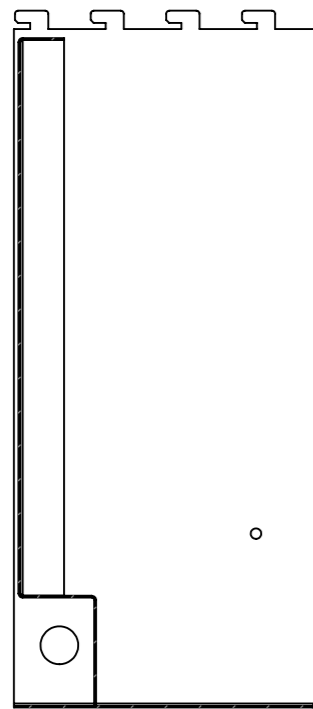
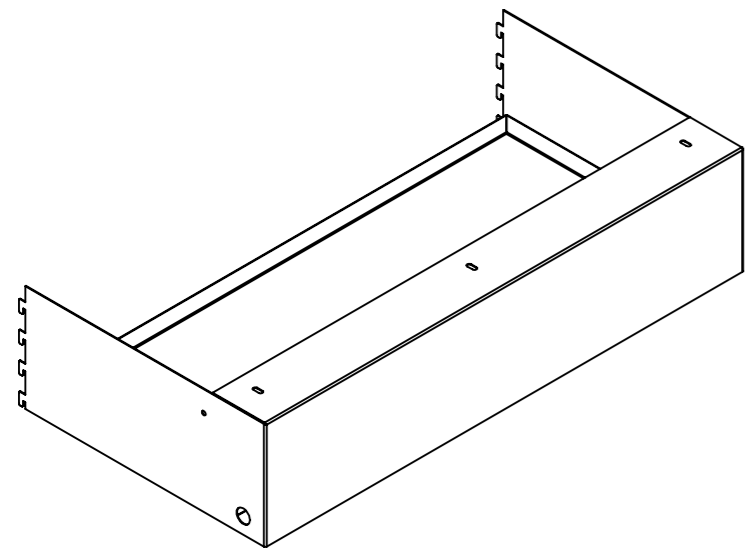

WELD INSIDE

SECTION A-A

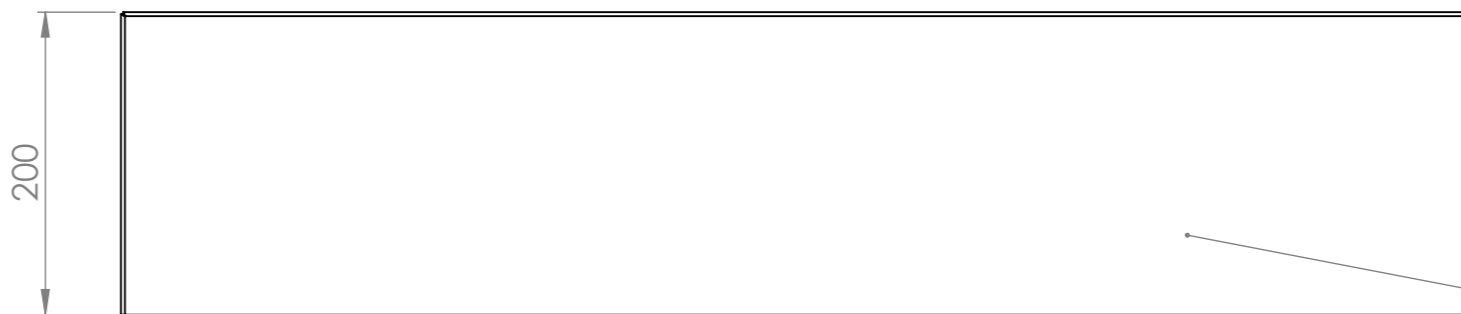
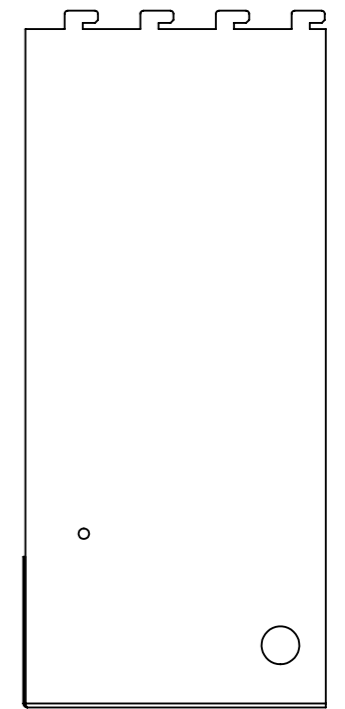
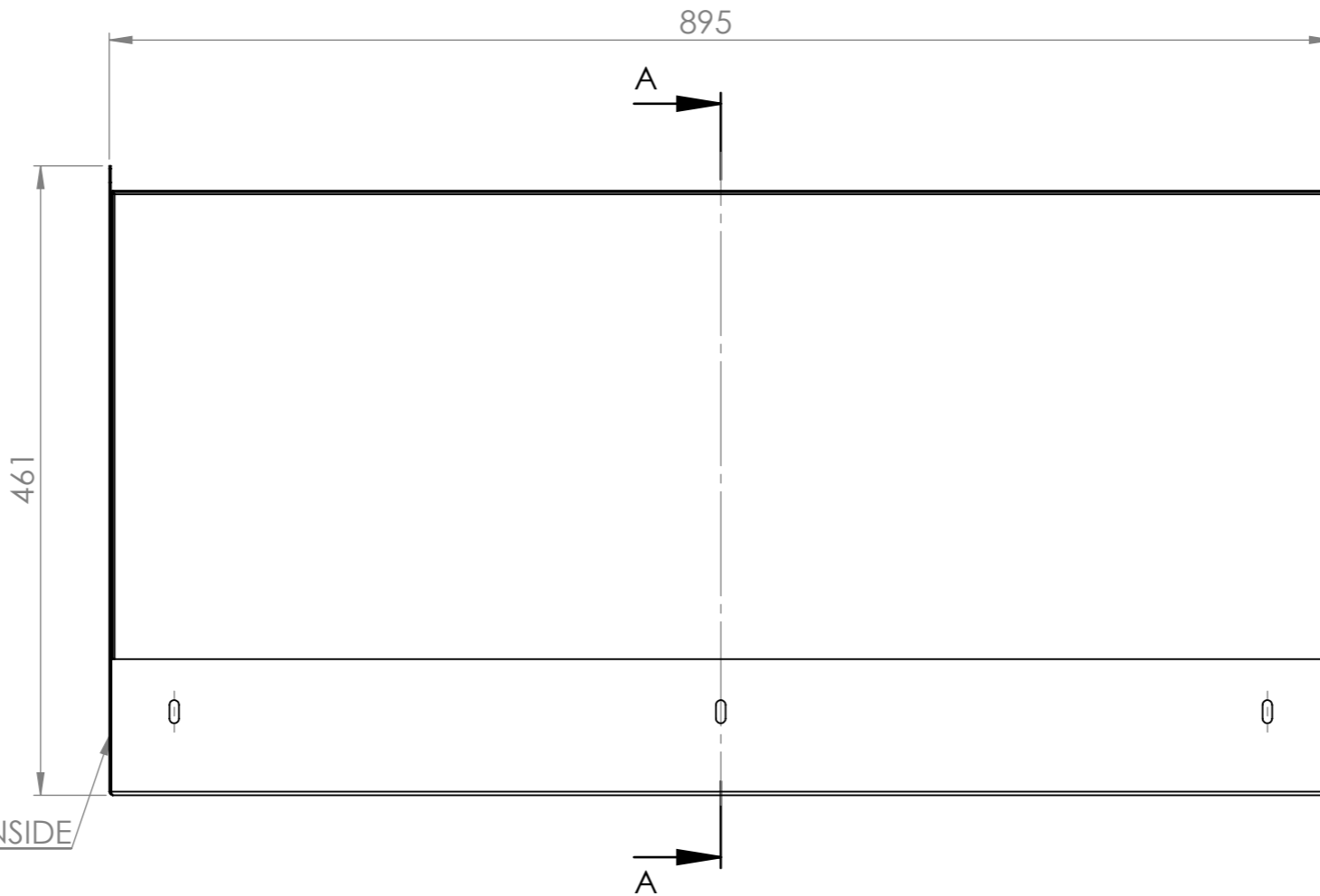

Rev	Date	Description

ALL DIMENSIONS IN (mm)
UNLESS OTHERWISE SPECIFIED
BREAK ALL SHARP EDGES

TOLERANCES
(BEFORE PAINTING
& AFTER PLATING)
X ± 1.00
X.X ± 0.50
X.XX ± 0.10
ANGLES ± 0.5°

A02- DIMENSIONS

CLIENT: JAKMAX
PROJ. NO.: TBA
PART NO.: --
Revision --
Page 2

900mm(W) x 200mm(H) x 450mm(D)
PELMET BOX

PRODUCT CODE: **RFA0251**

Date: 18/01/2024

Drawn by PS

Checked by --

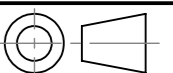

DO NOT SCALE

Scale@A3 1:5