



FINISH: PVC CLEAR WHITE BACKED

AP ASSOCIATED PROJECTS COMMERCIAL BUILDERS,
PROJECT MANAGERS,
PLANNERS & DESIGNERS

T 03 8787 3000 F 03 8787 3025
48-58 Cyber Loop, Dandenong South VIC 3175

Rev	Date	Description

ALL DIMENSIONS IN (mm)
UNLESS OTHERWISE SPECIFIED
BREAK ALL SHARP EDGES

TOLERANCES
(BEFORE PAINTING
& AFTER PLATING)
X ± 1.00
X.X ± 0.50
X.XX ± 0.10
ANGLES ± 0.5°

A01- RENDER
CLIENT: RFA
PROJ. NO.: TBA
PART NO.: --
Revision --
Page 1

DATA STRIP - ANGLED - W./ WHITE BACKED		
W900 x H26		
PRODUCT CODE: RFA0045		DO NOT SCALE Scale@A3 1:5
Date:	26/06/2024	
Drawn by	PS	
Checked by	--	

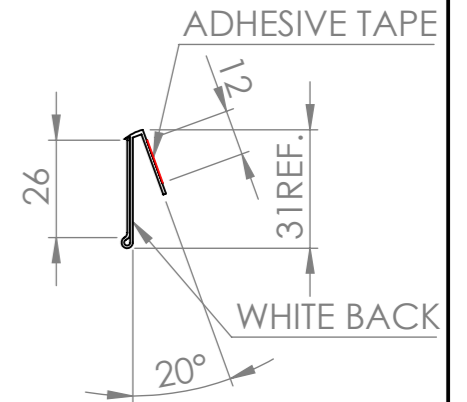
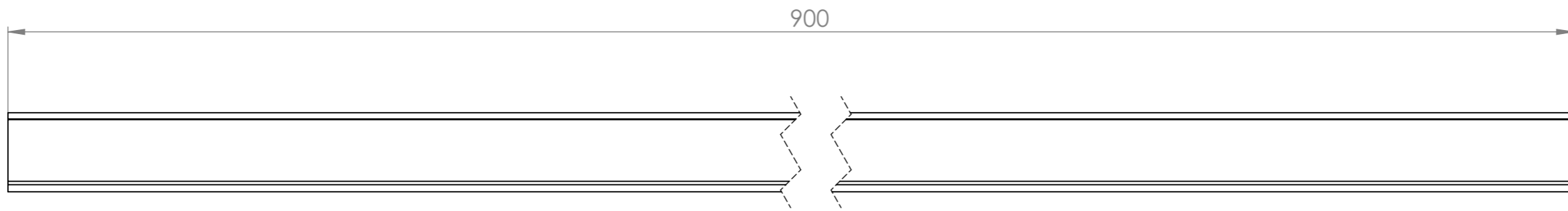
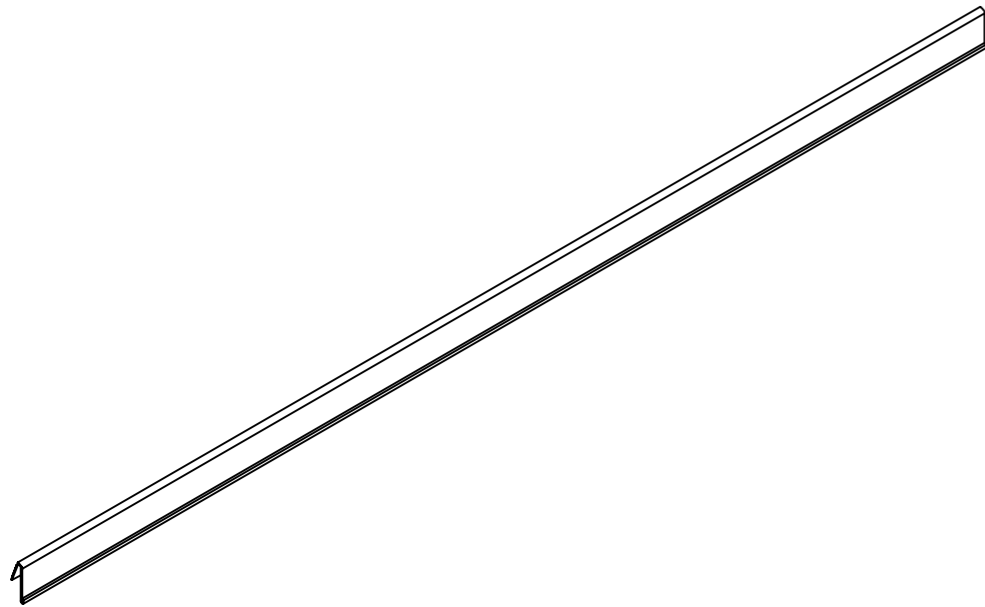

Rev	Date	Description

ALL DIMENSIONS IN (mm)
UNLESS OTHERWISE SPECIFIED
BREAK ALL SHARP EDGES

TOLERANCES
(BEFORE PAINTING
& AFTER PLATING)
X ± 1.00
X.X ± 0.50
X.XX ± 0.10
ANGLES ± 0.5°

A02- DIMENSIONS

CLIENT: RFA
PROJ. NO.: TBA
PART NO.: --
Revision --
Page 2

DATA STRIP - ANGLED - W./ WHITE BACKED
W900 x H26

PRODUCT CODE: **RFA0045**

Date: 26/06/2024

Drawn by PS

Checked by --

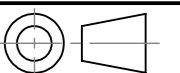

DO NOT SCALE

Scale@A3 1:2